

24CSJ SINGLE CORE STRAIGHT JOINT

Up to 24 kV

Application

For jointing copper wire screened polymeric cable to be laid in air or directly buried. The product is fully screened and fully submersible.

Technical characteristics

All joint bodies are tested for AC withstand prior to leaving the factory.

6/10 (12) kV
6.35/11 (12) kV
8.7/15 (17.5) kV
12/20 (24) kV
12.7/22 (24) kV

Design

Cold-shrinkable joint comprising:

1. Extruded triple layer EPDM rubber body.
2. Two layer plate with a semi-conductive and a field control mastic layer.
3. Overall protective EPDM cover.
4. Field control mastic.
5. Water sealing mastic.
6. Copper stocking.
7. Self-adhesive copper tape.
8. Traceability tag.
9. Conductor connector (not included in the standard kit).

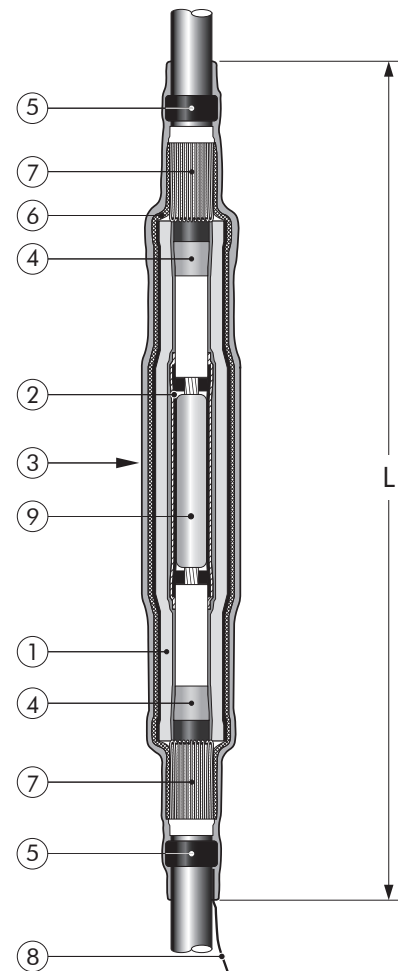

Specifications and standards

The cold-shrinkable 24CSJ joint meets the requirements of CENELEC HD 629.1.

Cold-shrinkable straight joint type	L (mm)	Diameter over outer sheath (mm)	Diameter over core insulation (mm)		Conductor sizes for 12kV (mm ²) (for information only)		Conductor sizes for 24 kV (mm ²) (for information only)	
		max	min	max	min	max	min	max
24CSJ-1	750	46	18	33	95	300	35	185
24CSJ-2	750	46	23	38	185	300	95	300
24CSJ-3	850	57	30	54	400	630	240	630

01/2012

Kit contents

A typical complete cold-shrinkable joint kit comprises the following components:

The kit also comprises a pulling hook, adhesive tape, lubricant, wipers, gloves and installation instructions.

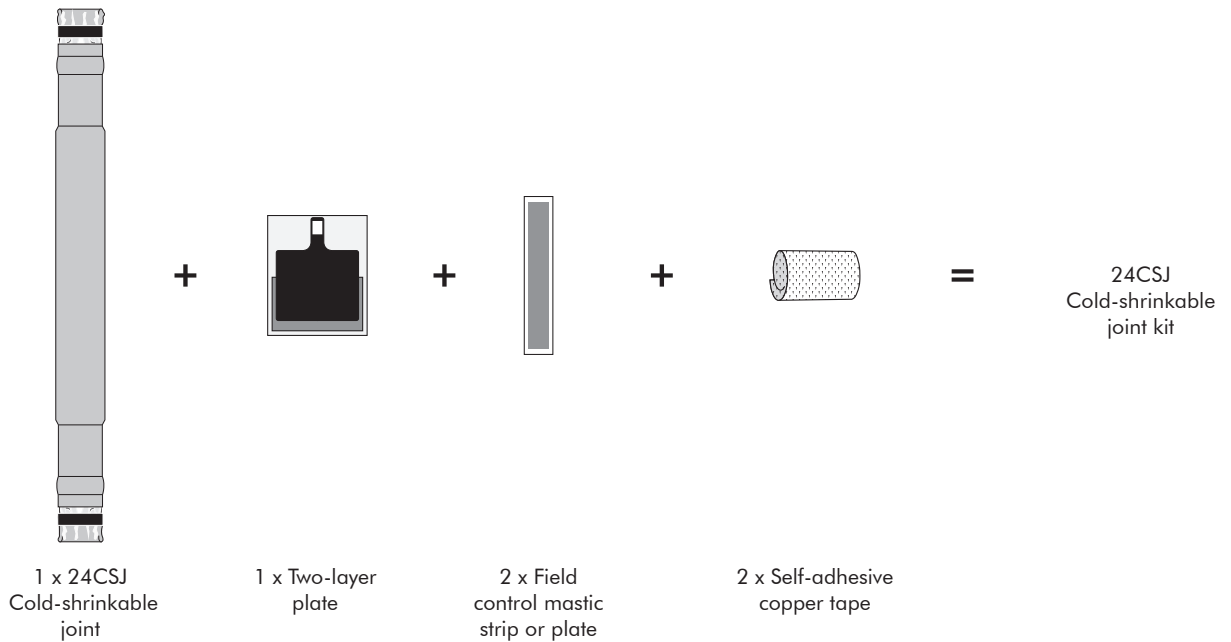

Ordering instructions

Select the part number corresponding to the cable core insulation diameter.

Ordering part number	Conductor sizes for 24 kV (mm ²) (for information only)												Diameter over core insulation (mm)	Diameter over outer sheath (mm)	
	35	50	70	95	120	150	185	240	300	400	500	630			
24CSJ-1	24CSJ-1													18 - 33	46 max
24CSJ-2				24CSJ-2										23 - 38	46 max
24CSJ-3							24CSJ-3							30 - 54	57 max

Example:

The copper wire screened cable is 24 kV, 120 mm² stranded aluminium with a diameter over core insulation of 25.3 mm. Order a 24CSJ-2 cold-shrinkable joint kit-45.

Joint type	L max (mm)	Dia max (mm)	T max (mm)
24CSJ-1	150	35	8
24CSJ-2	150	35	8
24CSJ-3	280	54	15

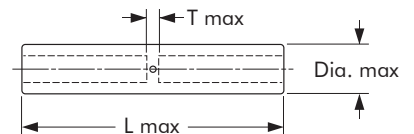

All types of conductor connectors can be used. The conductor connectors must be within the dimensions specified.

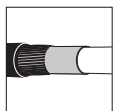

For use with copper wire screened cables. No earthing device is necessary. Order: -45.

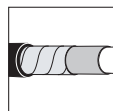

For use with copper tape screened cables. Order: -26

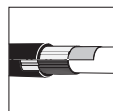

For use with Alupec or C 33-226 cables. Order: -07



For use with other cable types. Please contact our representative.



For use with three-core cables. See TT-24CSJ.

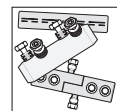

Can be supplied with all common types of conductor connectors.