



SOLUTIONS FOR ELECTRIC AND HYBRID VEHICLES OPERATIONS



THORNE &
DERRICK
INTERNATIONAL

Thorne & Derrick
+44 (0) 191 410 4292
www.powerandcables.com

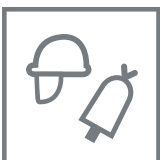

SPECIALIST IN ELECTRICAL
RISK PREVENTION



SICAME GROUP

ROLLER CABINET FOR ELECTRIC AND HYBRID VEHICLES

Finally a complete solution to perform
maintenance of electric and
hybrid vehicles
in total safety



MO-RC-EV1

CAN BE COMPLETED
WITH SAFETY TOOL KITS

EXPERT IN ELECTRICAL
RISK PREVENTION

WWW.CATUELEC.COM

CATUTM

SICAME GROUP



CONTENT

OVERVIEW OF ELECTRICAL OPERATIONS	4
GUIDE	7
PRODUCT CATALOGUE	
PPE / CPE	22
ROLLER CABINET	40
LIVE WORKING / DEAD WORKING	46
SIGNALING	65
LOCK-OUT / TAG-OUT	70
VOLTAGE DETECTORS AND MEASURES	74
KITS	80

VEHICLE LIFE CYCLE

Segment	Type of operations	Page
Design	Studies, Design, Testing, Alterations and Tests	
Manufacture	Crash test – Homologation	
Maintenance	Lock-out and Tag-out of electric vehicle	
	Dead working on electric & hybrid vehicles after lock-out/tag-out operation	
	Live working operations	
Control	Technical inspections	
Appraisal	Vehicle appraisal	
Rescue and recovery	Vehicle recovery operations, Towing	
	Emergency Operations	
End of life	Vehicle / Electric vehicle deconstruction operations	

1 - DESIGN AND MANUFACTURE

Electrical hazard thresholds



- Direct current: nominal voltage difference greater than 60 V DC.
- Alternative current: potential difference greater than 25 V AC.
- Batteries: capacity greater than 180 Ah.

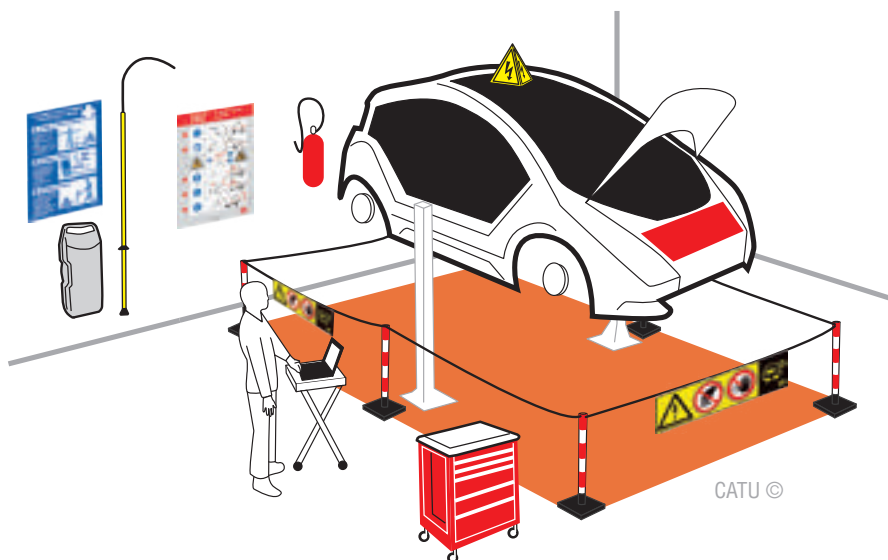

2 - MAINTENANCE

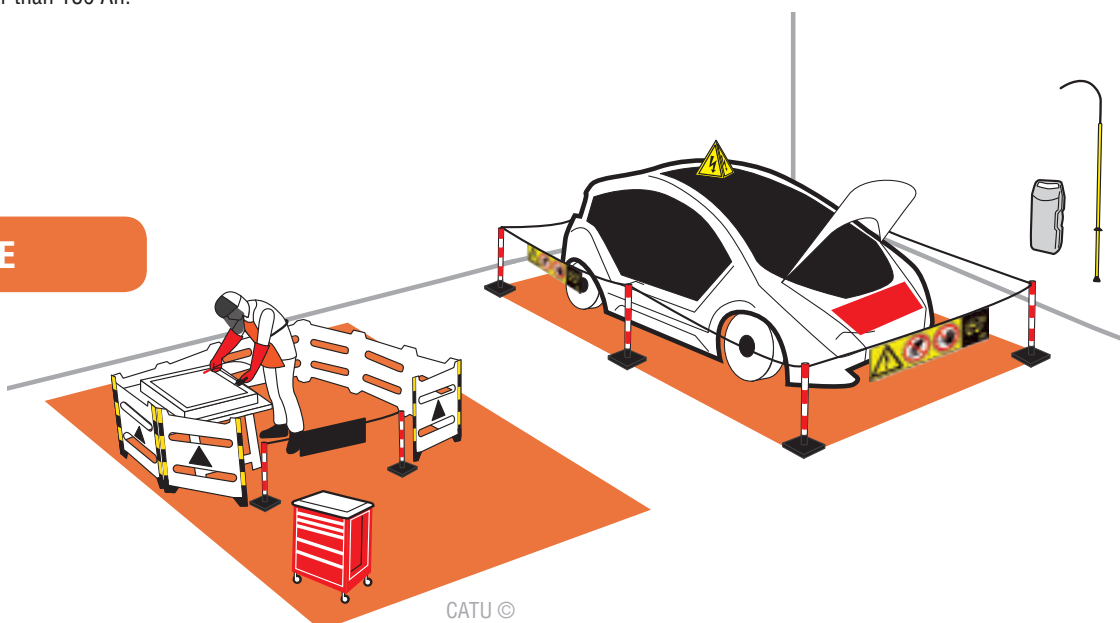

OVERVIEW OF ELECTRICAL OPERATIONS VEHICLES AND MACHINES WITH ON-BOARD ELECTRICAL ENERGY SOURCE

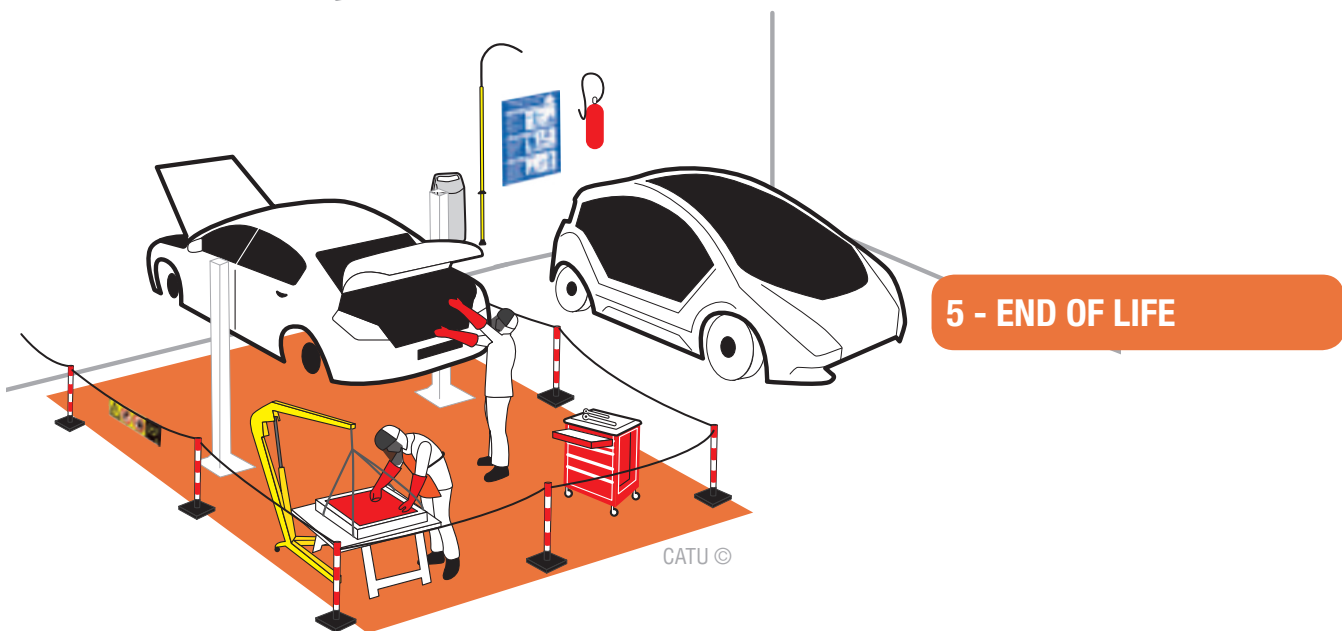
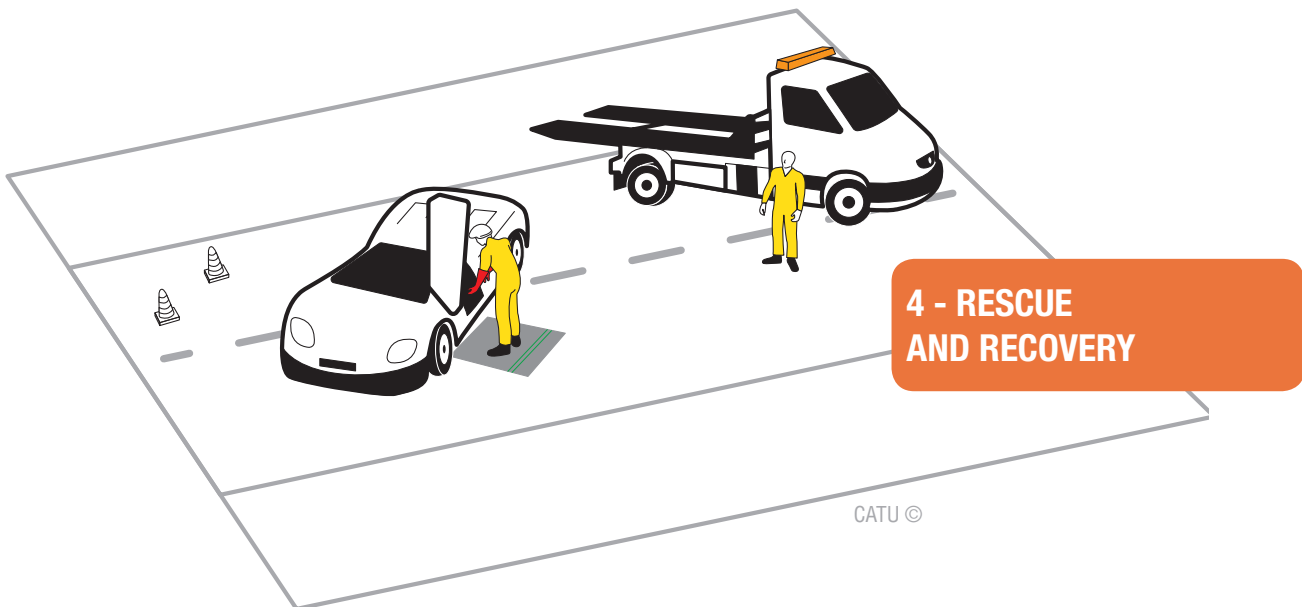
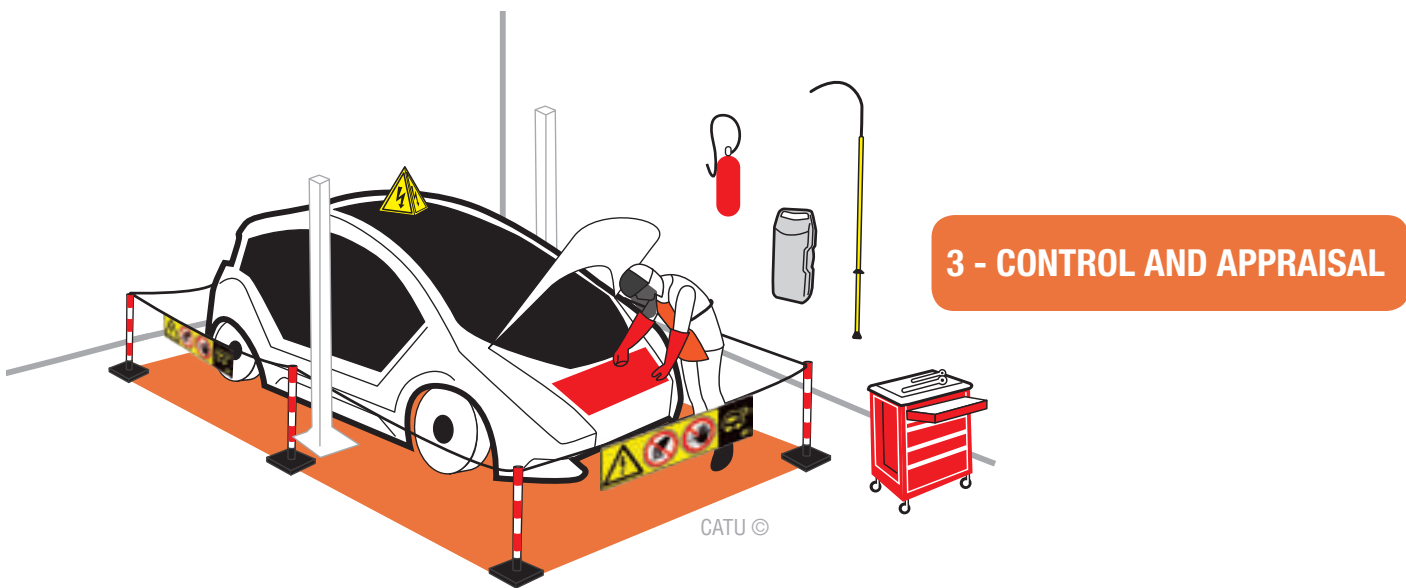

SHORT INSULATING GLOVES

CG-00-[*]-R-28 AND CG-0-[*]-R-28

DEXTERI 
Wellfit

IEC 60903: 2014
EN 60903: 2003



NEW!

INSULATING GLOVES FOR A PERSONAL PROTECTION AGAINST AN ELECTRIC ARC DURING LIVE OPERATIONS.

- Class 00 (750 V DC) and Class 0 (1 500 V DC) insulating gloves.
- **Wellfit finish:** soft, supple, resistant and ergonomic with high flexibility for an easy daily work.
- Class 00: Arc-Flash protection ATPV 6 cal / cm², APC 1.
- Battery acid resistance.
- Rolled cuff for comfort and ease of donning and doffing.

**MAXIMUM OPERATING VOLTAGE :
750 V DC / 1 500 V DC**

28 cm LENGTH, IDEAL FOR WORKING ON BATTERIES.

Reference	↔ (mm)	Class	⎓	⎓⎓	Category
CG-00-* -R-28	280	00	500 V AC	750 V DC	AZC
CG-0-* -R-28	280	0	1 000 V AC	1 500 V DC	AZC

(*) The reference will be completed with the size codes from 07 to 12.



GUIDE

DESIGN	8
MANUFACTURE	9
MAINTENANCE	10
CONTROL	14
APPRAISAL	15
ASSISTANCE AND REPAIRS	16
END OF LIFE	18

OPERATIONS

- Short duration.
 - Conduct Studies, Design, Testing and Alteration operations, after lock-out/tag-out or power switch-off.
 - To install and uninstall vehicle components.
 - Measurement of physical data in the vehicle.
 - Check the equipment is in good order and monitor it.
 - Carry out connection/disconnection operation of battery with voltage $U \leq 60$ V DC or with capacity $C \leq 180$ Ah.
- For higher values, refer to Live-working operations (page 12).

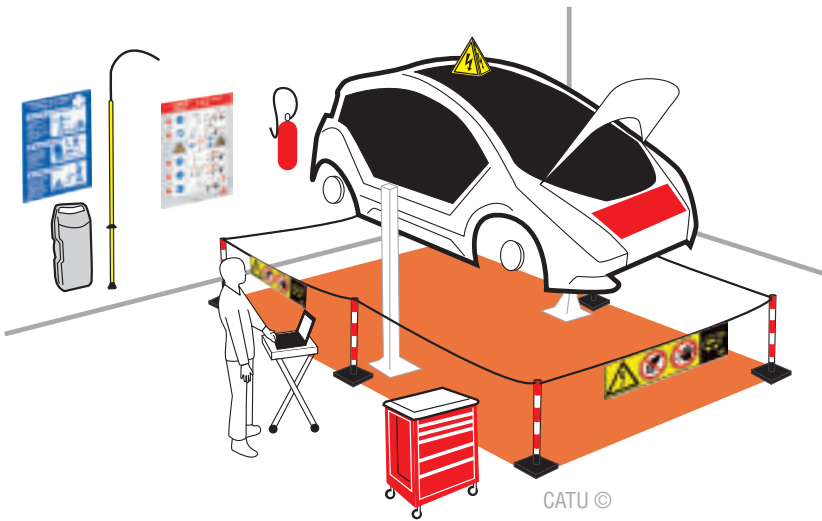

- It is forbidden to work without insulating gloves and without face shield in the vicinity of live energy sources.
- It is forbidden to use a measuring device to carry out a voltage absence check.

Products	Pages
Face shield	23
Helmet	23
Insulating gloves	25
Safety footwear with insulating sole	28
Insulating boots, insulating over shoes	29
Insulating protector, insulating blanket, sleeve, insulating mat	30,31
Arc-flash protective clothing	37
Insulated tools	46



Products	Pages
Signaling	65
Lock-out / Tag-out	70
Voltage detectors	74
Multimeters	76
Luggage	79
Additional tools: Rescue Pole, Kits	38
Extinguisher	39
Roller Cabinet	40

OPERATIONS (AFTER CRASH TEST)

- Identify damage of the electric vehicle.
- Assess HAZARDS (electrical, chemical, fire, etc.).
- Set up insulating protections to eliminate a RISK of voltage presence (installation of an insulating device such as an insulating blanket or a sleeve).
- Carry out and record all TEST measurements.
- Store and secure the vehicle. Tag it out in case of ELECTRICAL RISK.
- Carry out the connection/disconnection operation of battery of voltage $U \leq 60 \text{ V DC}$ or with capacity $C \leq 180 \text{ Ah}$. For higher values, refer to Live-working operations (page 12).



- It is forbidden to work without insulating gloves and without face shield in the vicinity of live energy sources.
- It is forbidden to use a measuring device to carry out a voltage absence check.



Products	Pages
Face shield	23
Helmet	23
Insulating gloves	25
Safety footwear with insulating sole	28
Insulating boots, insulating over shoes	29
Insulating protector, insulating blanket, sleeve, insulating mat	30,31
Arc-flash protective clothing	37
Insulated tools	46

Products	Pages
Signaling	65
Lock-out / Tag-out	70
Voltage detectors	74
Multimeters	76
Luggage	79
Additional tools: Rescue Pole, Kits	38
Extinguisher	39
Roller Cabinet	40

OPERATIONS

- Initiate the lock-out procedure.
- Identify the vehicle.
- Delineate and tag-out the working area.
- Isolate voltage sources.
- Lock-out all switches and elements in the “OFF” position.
- Check the absence of voltage.



- It is forbidden to work without insulating gloves and without face shield in the vicinity of live energy sources.
- It is forbidden to use a measuring device to carry out a voltage absence check.

Prior to the lock-out operation, select the adequate equipment for the planned operations:



Face shield, insulating gloves, voltage detector, padlock, safety boundary post and chain.

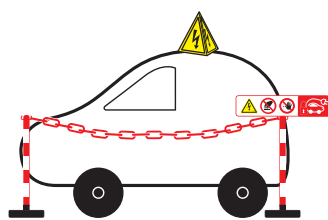

1) Identify the vehicle and delineate the work area.

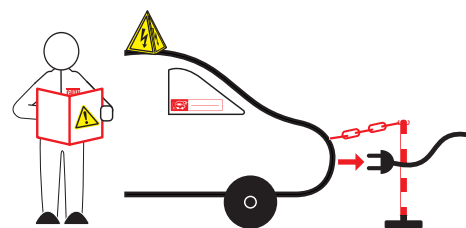

2) Isolate voltage sources.

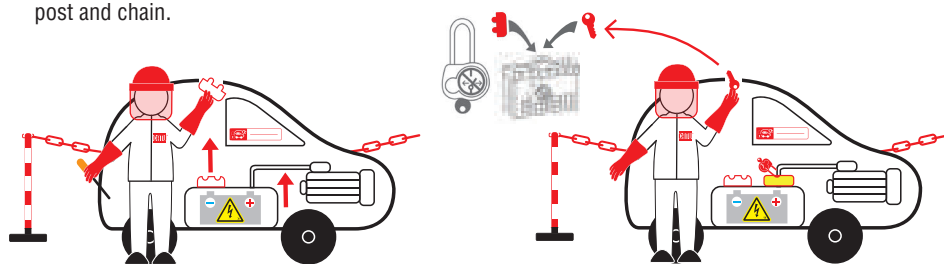

3) Lock in «OFF position»

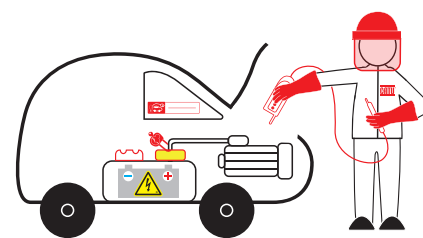

4) Check the absence of voltage at the connection terminals.



- It is forbidden to work without insulating gloves and without face shield in the vicinity of live energy sources.
- It is forbidden to use a measuring device to carry out a voltage absence check.

Products	Pages
Face shield	23
Helmet	23
Insulating gloves	25
Safety footwear with insulating sole	28
Insulating boots, insulating over shoes	29
Insulating protector, insulating blanket, sleeve, insulating mat	30,31
Arc-flash protective clothing	37
Insulated tools	46

Products	Pages
Signaling	65
Lock-out / Tag-out	70
Voltage detectors	74
Multimeters	76
Luggage	79
Additional tools: Rescue Pole, Kits	38
Extinguisher	39
Roller cabinet	40

OPERATIONS

- Work performed on the electrical equipment after voltage switch-off.
- Work carried out around the electrical equipment after voltage switch-off.
- Work carried out in vicinity of the electrical insulated cable sleeves.

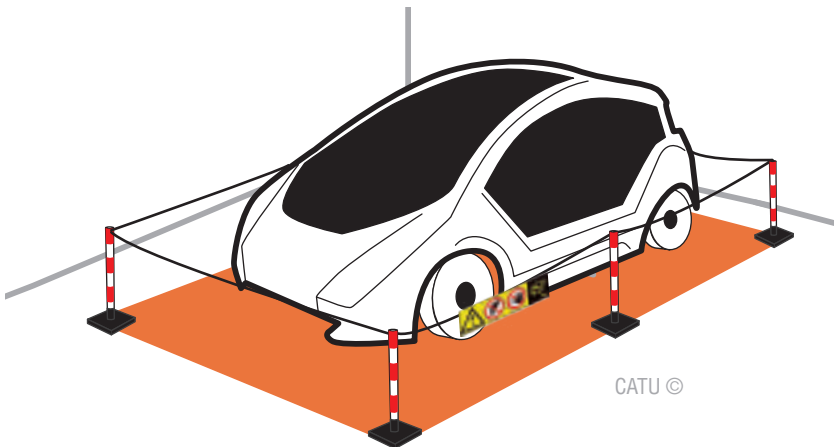

CATU ©



- It is forbidden to work without insulating gloves and without face shield in the vicinity of live energy sources.
- It is forbidden to use a measuring device to carry out a voltage absence check.

Products	Pages
Face shield	23
Helmet	23
Insulating gloves	25
Safety footwear with insulating sole	28
Insulating boots, insulating over shoes	29
Insulating protector, insulating blanket, sleeve, insulating mat	30,31
Arc-flash protective clothing	37
Insulated tools	46

Products	Pages
Signaling	65
Lock-out / Tag-out	70
Voltage detectors	74
Multimeters	76
Luggage	79
Additional tools: Rescue Pole, Kits	38
Extinguisher	39
Roller cabinet	40

OPERATIONS

- Work in contact with live bare parts.
- Assemble elements to form a battery pack.
- Install/uninstall the battery pack(s) or batteries.
- Replace one or more battery cells.
- Maintain terminals, bare connections or battery housing.
- Disassemble a battery pack.
- Carry out operation on batteries with capacity $C > 180 \text{ Ah}$ or voltage $> 60 \text{ V DC}$.

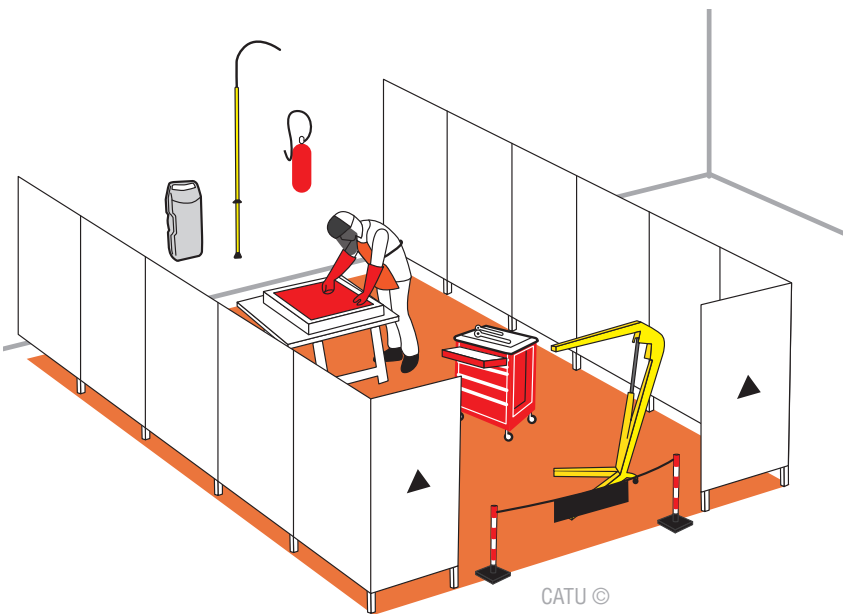

CATU ©



- It is forbidden to use a measuring device to carry out a voltage absence check.



Products	Pages
Face shield	23
Helmet	23
Insulating gloves	25
Safety footwear with insulating sole	28
Insulating boots, insulating over shoes	29
Insulating protector, insulating blanket, sleeve, insulating mat	30,31
Arc-flash protective clothing	37
Insulated tools	46

Products	Pages
Signaling	65
Lock-out / Tag-out	70
Voltage detectors	74
Multimeters	76
Luggage	79
Additional tools: Rescue Pole, Kits	38
Extinguisher	39
Roller cabinet	40

OPERATIONS

For BATTERIES:

- Make connection/disconnection operations.
 - Clean terminals and connectors.
 - Handle, check the batteries.
 - Check the electrolyte.
 - Clean the battery housing when the voltage is $U > 60$ V DC.
 - Carry out connection/disconnection operations of battery with voltage $U \leq 60$ V DC or with capacity $C \leq 180$ Ah.
- For higher values, refer to Live-working operations (page 12).

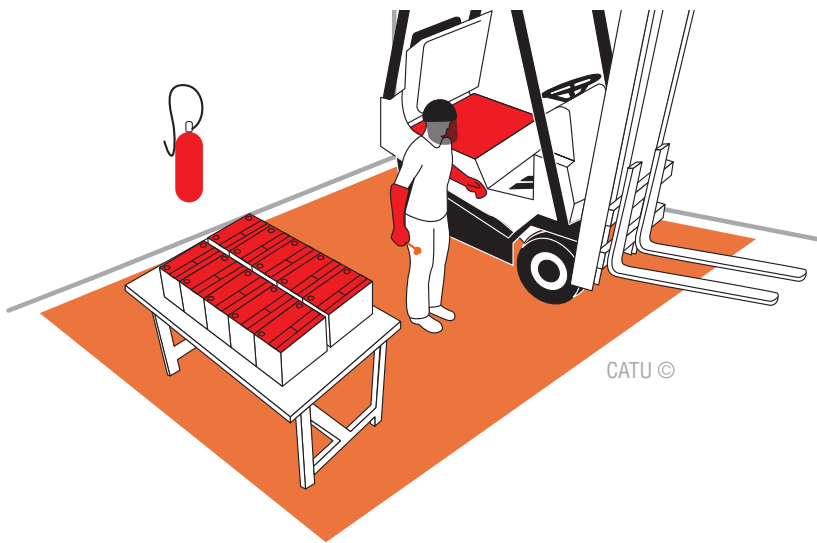

For the SUPERCAPACITORS:

Connection/disconnection of SUPERCAPACITOR with bare parts.



- It is forbidden to work without insulating gloves and without face shield in the vicinity of live energy sources.
- It is forbidden to use a measuring device to carry out a voltage absence check.

For fuel cells:

Measurement of the cell before connection/disconnection is allowed within the limit of VOLTAGE $U \leq 60$ V DC. For higher values, refer to Live-working operations (page 12).

Products	Pages
Face shield	23
Helmet	23
Insulating gloves	25
Safety footwear with insulating sole	28
Insulating boots, insulating over shoes	29
Insulating protector, insulating blanket, sleeve, insulating mat	30,31
Arc-flash protective clothing	37
Insulated tools	46

Products	Pages
Signaling	65
Lock-out / Tag-out	70
Voltage detectors	74
Multimeters	76
Luggage	79
Additional tools: Rescue Pole, Kits	38
Extinguisher	39
Roller cabinet	40

OPERATIONS

- Make sure the vehicle is switched-off state during the inspection.
- Check the condition of electrical equipment, connectors, batteries, or battery pack(s) and loading interface.
- Check the integrity of the insulating components.
- Carry out the connection/disconnection operation of the battery with voltage $U \leq 60 \text{ V DC}$ and with capacity $C \leq 180 \text{ Ah}$. For higher values, refer to Live-working operations (page 12).

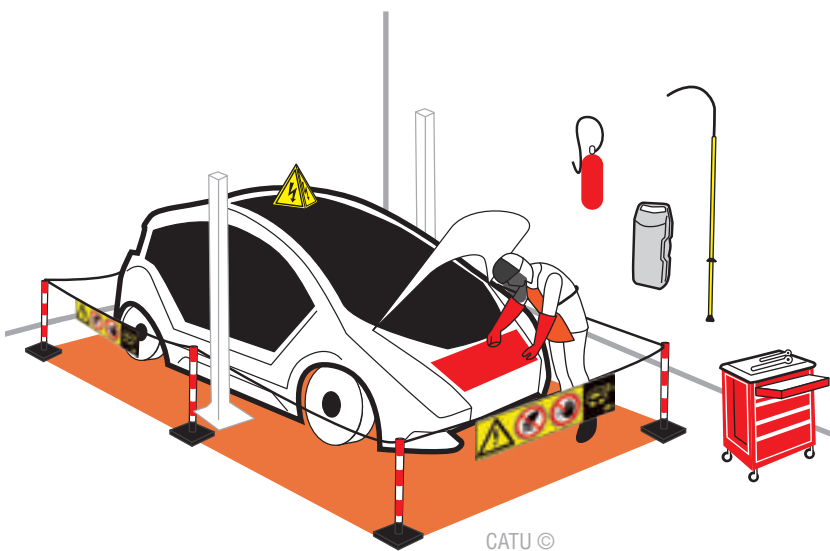

- It is forbidden to work without insulating gloves and without face shield in the vicinity of live energy sources.
- It is forbidden to use a measuring device to carry out a voltage absence check.



Products	Pages
Face shield	23
Helmet	23
Insulating gloves	25
Safety footwear with insulating sole	28
Insulating boots, insulating over shoes	29
Insulating protector, insulating blanket, sleeve, insulating mat	30,31
Arc-flash protective clothing	37
Insulated tools	46

Products	Pages
Signaling	65
Lock-out / Tag-out	70
Voltage detectors	74
Multimeters	76
Luggage	79
Additional tools: Rescue Pole, Kits	38
Extinguisher	39
Roller cabinet	40

OPERATIONS

- Assess the risk before the appraisal.
- Vehicle appraisal.

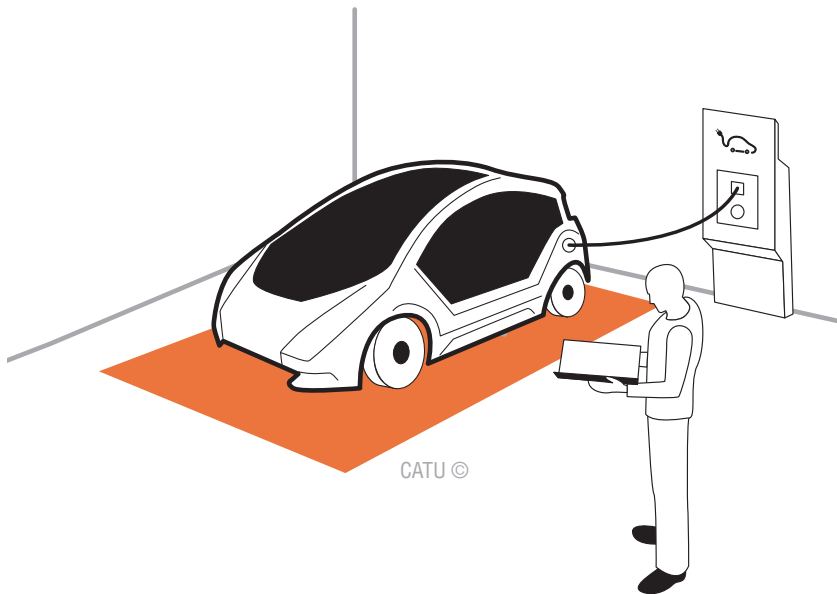

- It is forbidden to use a measuring device to carry out a voltage absence check.

Products	Pages
Face shield	23
Helmet	23
Insulating gloves	25
Safety footwear with insulating sole	28
Insulating boots, insulating over shoes	29
Insulating protector, insulating blanket, sleeve, insulating mat	30,31
Arc-flash protective clothing	37
Insulated tools	46

Products	Pages
Signaling	65
Lock-out / Tag-out	70
Voltage detectors	74
Multimeters	76
Luggage	79
Additional tools: Rescue Pole, Kits	38
Extinguisher	39
Roller cabinet	40

OPERATIONS

On a broken down vehicle:

- Refer to the manufacturer instructions.
- Locate the electrical insulated cable sleeves in the event of lifting.
- Identify the short-circuit risks in the event of changing auxiliary battery.

On an accident-damaged vehicle:

- Analyse the risks.
- Ensure the safety of third parties.
- Identify the type of vehicle.
- Identify the damages to the vehicle.
- Power down the vehicle.
- Carry out connection/disconnection operation of the battery with voltage $U \leq 60 \text{ V DC}$ or with capacity $C \leq 180 \text{ Ah}$. For higher values, refer to Live-working operations (page 12).

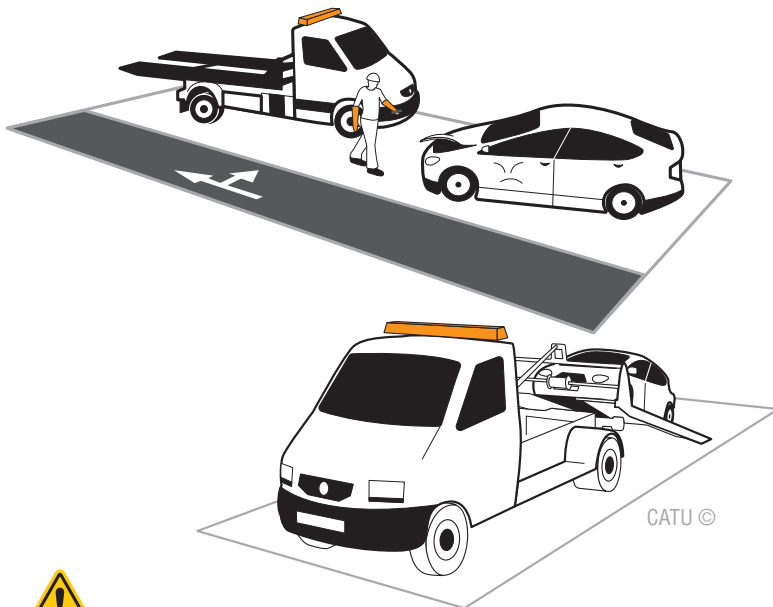

- It is forbidden to work without insulating gloves and without face shield in the vicinity of live energy sources.
- It is forbidden to use a measuring device to carry out a voltage absence check.



Products	Pages
Face shield	23
Helmet	23
Insulating gloves	25
Safety footwear with insulating sole	28
Insulating boots, insulating over shoes	29
Insulating protector, insulating blanket, sleeve, insulating mat	30,31
Arc-flash protective clothing	37
Insulated tools	46

Products	Pages
Signaling	65
Lock-out / Tag-out	70
Voltage detectors	74
Multimeters	76
Luggage	79
Additional tools: Rescue Pole, Kits	38
Extinguisher	39
Roller cabinet	40

OPERATIONS

- Assess the risks.
- Ensure the safety of third parties.
- Identify the damages to the charging device.
- Eliminate the risk of voltage presence in working area by placing the blanket and/or insulating protectors.
- Power down the charging device and the vehicle.
- Carry out the connection/disconnection operation of the battery with voltage $U \leq 60$ V DC or with capacity $C \leq 275$ Ah. For higher values, refer to Live-working operations (page 12).

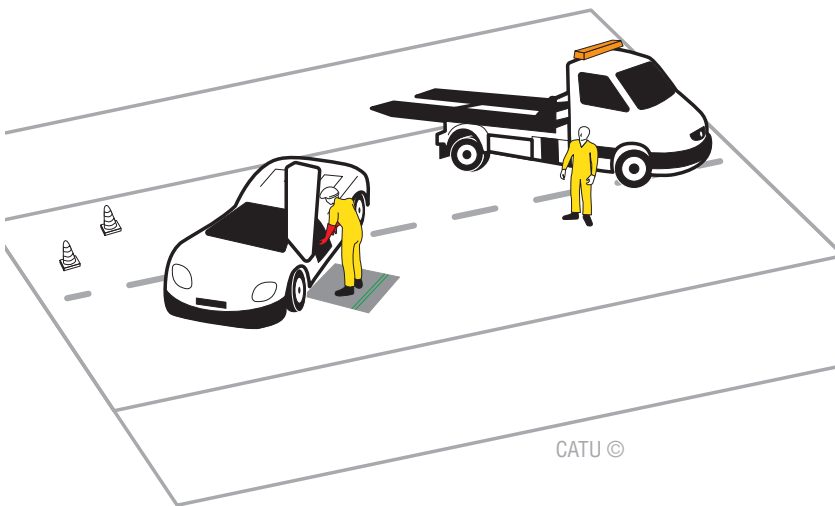

- It is forbidden to work without insulating gloves and without face shield in the vicinity of live energy sources.
- It is forbidden to use a measuring device to carry out a voltage absence check.



Products	Pages
Face shield	23
Helmet	23
Insulating gloves	25
Safety footwear with insulating sole	28
Insulating boots, insulating over shoes	29
Insulating protector, insulating blanket, sleeve, insulating mat	30,31
Arc-flash protective clothing	37
Insulated tools	46

Products	Pages
Signaling	65
Lock-out / Tag-out	70
Voltage detectors	74
Multimeters	76
Luggage	79
Additional tools: Rescue Pole, Kits	38
Extinguisher	39
Roller cabinet	40

OPERATIONS

- Assess the risk in case of presence of energy source.
- Park the vehicle in a protected area with warning signs.
- Check the absence of voltage after a permanent shutdown.
- Remove and store the batteries in a safe place.
- Carry out the connection/disconnection operation of the battery with voltage $U \leq 60$ V DC or with capacity $C \leq 275$ Ah. In the event of higher values, refer to the Live-working operations (page 12).

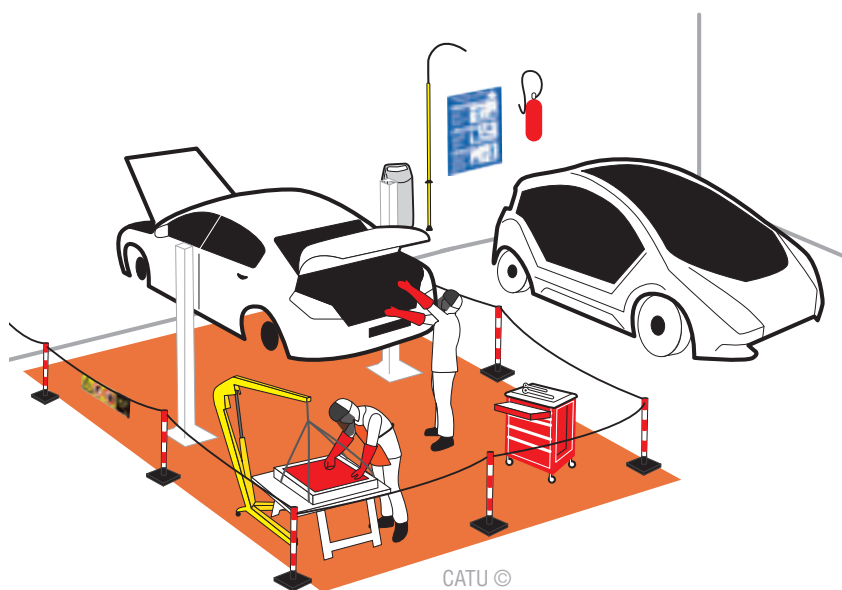

- It is forbidden to work without insulating gloves and without face shield in the vicinity of live energy sources.
- It is forbidden to use a measuring device to carry out a voltage absence check.



Products	Pages
Face shield	23
Helmet	23
Insulating gloves	25
Safety footwear with insulating sole	28
Insulating boots, insulating over shoes	29
Insulating protector, insulating blanket, sleeve, insulating mat	30,31
Arc-flash protective clothing	37
Insulated tools	46

Products	Pages
Signaling	65
Lock-out / Tag-out	70
Voltage detectors	74
Multimeters	76
Luggage	79
Additional tools: Rescue Pole, Kits	38
Extinguisher	39
Roller cabinet	40

CATALOGUE ALPHABETICAL INDEX

3/8" Insulated tool set.....51	I nfrared thermometer77	P arka "arc flash".....38
3/8" Torx insulated socket50	Insulated bi-material flat blade screwdriver55	Plastic chain.....68
6 - 12 Sided insulating sockets49	Insulated bi-material hexagonal screwdriver.....57	Plastic poster for HEV65
6 Sides male socket48	Insulated bi-material phillips screwdriver56	Plastic warning sign (set of 10 units)71
	Insulated bi-material pozidriv screwdriver56	Pneumatic tester for insulating gloves27
	Insulated bi-material torx screwdriver57	PPE, locking and signaling equipment kit41
	Insulated bits for MO-7200-DYN.....58	Protective covers for helmets and visors24
	Insulated cable cutter.....54	Protective equipment kit for live working41
	Insulated dead-blow hammer.....61	
	Insulated knives62	
	Insulated mirror61	
	Insulated ratchet wrench.....53	
	Insulated tools kit84	
	Insulating adaptor.....53	
	Insulating bag32	
	Insulating blanket.....31	
	Insulating blanket class 0.....30	
	Insulating blanket class 0.....31	
	Insulating boots class 029	
	Insulating brush.....61	
	Insulating cap class 033	
	Insulating device to lift up battery.....46	
	Insulating mat class 035	
	Insulating mats36	
	Insulating overboots class 129	
	Insulating pliers59	
	Insulating tool with wedge-shaped blade73	
	Insulation torque screwdriver58	
	Ip2x safety alligator clips78	
	Ip2x safety cords for test lead points77	
	Ip2x safety test lead points and cords.....78	
	K it for lock-out tag-out operations.....81	
	Kit of 13 insulated tools44	
	Kit of 17 insulated 3/8" square drive tools.....43	
	Kit of 28 insulated tools42	
	L eather overgloves26	
	Live-working operations12	
	Lockout station70	
	Low voltage detector detex74	
	M agnetic signal pyramid "electric hazard"65	
	Magnet on flexible handle60	
	Mechanical and Arc-Flash insulating gloves.....26	
	O range insulating blanket class 0.....30	
	Oversized plug and hoist control lockout73	
3/8" Insulated tool set.....51		
3/8" Torx insulated socket50		
6 - 12 Sided insulating sockets49		
6 Sides male socket48		
A C and DC voltage controller74		
Adhesive plastic poster for HEV A4 format66		
Adjustable torque wrench 3/8".....48		
Adjustable wrench.....55		
Alumetal™ warning sign66		
Arc-Flash face shield with headband23		
B ackpack with wheels for electrician.....64		
Bags.....79		
Bi-material insulated tools kit.....60		
Boundary post for delineation of a working area...67		
C arrying bag for blankets and36		
Cat'arc multi-risk clothing37		
Clamp for insulating blanket33		
Complete PPE kit for training.....82		
Contact probes for I.V. detectors.....75		
D elineation kit.....80		
Digital multimeter76		
E lastomer insulating apron34		
Electrical insulating gloves: 28 cm.....25		
Electrical insulating gloves: 36 cm.....25		
Electrical plug lockout.....72		
Electrician helmet with integrated face shield23		
Electrician tool bag62		
Essential PPE kit83		
Expander female to male47		
Extinguisher for Li-ion battery39		
F olding safety barrier67		
G loves box and bag for insulating gloves.....27		
Group lock box.....70		
H ead and hand protection kit85		
Headlamp.....24		
HEV vehicle repair kit87		
R atchets and accessories.....47		
Rescue stick with insulated hook non removable...38		
Rescue wall kit45		
Roller cabinet for HEV operations40		
S afety glasses22		
Safety over glasses22		
Safety padlock.....71		
Safety shoes with insulating28		
Safety shoes with insulating sole, leather type.....28		
Set of 40 temporary stickers "damaged vehicle" ...66		
Signaling / delineation tape69		
Sole, textile type28		
Steering wheel cover.....72		
Storage boxes for accessories and tools.....63		
Strap for insulating mats.....36		
T extile tool box.....62		
T-handle wrench54		
Tool bag with reinforced base63		
U ndergloves for insulating gloves.....27		
W renches and spanners.....52		

REFERENCES INDEX

Reference	Page	Reference	Page	Reference	Page	Reference	Page	Reference	Page
ACA-10.....	65	KIT-VEH-C.....	81	MO-745D.....	61	MO-68108.....	52	MO-69003.....	55
AFG-1001-*.....	37	KIT-VEHC-TEC.....	85	MO-755D.....	61	MO-68109.....	52	MO-69005.....	55
AFG-2000-*.....	37	KIT-VEH-DEP.....	86	MO-810.....	46	MO-68110.....	52	MO-69025.....	48
AFG-2001-*.....	37	KIT-VEH-GEXP.....	88	MO-7200DYN.....	58	MO-68111.....	52	MO-69050.....	48
AFG-2300-*.....	37	KIT-VEH-GPRO.....	87	MO-7200-PH2.....	58	MO-68112.....	52	MO-69051.....	48
AL-31.....	68	KIT-VEH-PPE.....	83	MO-7200-PZ1.....	58	MO-68113.....	52	MO-69054.....	48
AL-31/05.....	68	KIT-VEH-PPE/02.....	82	MO-7200-PZ2.....	58	MO-68114.....	52	MO-69210.....	53
AL-31/25.....	68	KIT-VEH-V-TST.....	84	MO-7200-SL4.....	58	MO-68115.....	52	MO-69213.....	53
AL-32/05.....	68	M-87285.....	79	MO-7200-SL25.....	58	MO-68116.....	52	MO-69217.....	53
AL-32/25.....	68	M-87290.....	79	MO-7200-SL55.....	58	MO-68117.....	52	MO-69219.....	53
AL-139.....	69	M-87292.....	79	MO-7200-T15.....	58	MO-68118.....	52	MO-69306.....	49
AL-140.....	69	M-87303.....	62	MO-7200-T20.....	58	MO-68119.....	52	MO-69307.....	49
AL-316.....	67	M-87384.....	24	MO-7200-T25.....	58	MO-68120.....	52	MO-69308.....	49
AL-318.....	67	M-882452.....	63	MO-7582-D.....	60	MO-68121.....	52	MO-69308/23.....	51
AL-323.....	67	M-883374.....	38	MO-11000.....	22	MO-68122.....	52	MO-69309.....	49
AL-324.....	67	M-883377.....	38	MO-11001.....	22	MO-68123.....	52	MO-69310.....	49
AL-325.....	67	M-883378.....	38	MO-11010.....	22	MO-68124.....	52	MO-69311.....	49
AL-326.....	67	M-883379.....	38	MO-61001.....	62	MO-68125.....	52	MO-69312.....	49
AL-328.....	67	M-883380.....	38	MO-61002.....	62	MO-68126.....	52	MO-69313.....	49
ALPV-L-D.....	72	M-883381.....	38	MO-66000C.....	59	MO-68127.....	52	MO-69314.....	49
ALPV-XL-D.....	72	MO-39.....	62	MO-66303C.....	59	MO-68128.....	52	MO-69315.....	49
AM-20 GB.....	66	MO-42/1.....	63	MO-66404CC.....	59	MO-68129.....	52	MO-69316.....	49
AP-72.....	65	MO-42/2.....	63	MO-67501.....	54	MO-68130.....	52	MO-69317.....	49
AP-460.....	71	MO-43.....	79	MO-67502.....	54	MO-68132.....	52	MO-69318.....	49
AP-550-M2V.....	65	MO-44.....	64	MO-68006.....	52	MO-68206.....	52	MO-69319.....	49
AP-550-M3.....	65	MO-69T15.....	50	MO-68007.....	52	MO-68207.....	52	MO-69321.....	49
AT-81.....	66	MO-69T20.....	50	MO-68008.....	52	MO-68208.....	52	MO-69322.....	49
AT-5005.....	69	MO-69T25.....	50	MO-68009.....	52	MO-68209.....	52	MO-69323.....	49
ATP-551-B.....	66	MO-69T30.....	50	MO-68010.....	52	MO-68310.....	54	MO-69324.....	49
CD-307.....	39	MO-69T40.....	50	MO-68011.....	52	MO-68311.....	54	MO-69393.....	48
CG-00-* -R-28.....	25	MO-69T50.....	50	MO-68012.....	52	MO-68312.....	54	MO-69394.....	48
CG-0-* -R-28.....	25	MO-160.....	36	MO-68013.....	52	MO-68313.....	54	MO-69395.....	48
CG-10.....	25	MO-161.....	36	MO-68014.....	52	MO-68314.....	54	MO-69396.....	48
CG-35-2.....	27	MO-185-BL.....	23	MO-68015.....	52	MO-68316.....	54	MO-69397.....	48
CG-36-1.....	27	MO-286.....	23	MO-68016.....	52	MO-68317.....	54	MO-69398.....	48
CG-80-*.....	27	MO-600.....	73	MO-68017.....	52	MO-68319.....	54	MO-69408.....	49
CG-117.....	27	MO-694M04.....	48	MO-68018.....	52	MO-68321.....	54	MO-69409.....	49
CG-981-*.....	26	MO-694M05.....	48	MO-68019.....	52	MO-68322.....	54	MO-69410.....	49
CGM-0.....	26	MO-694M06.....	48	MO-68020.....	52	MO-68402.....	57	MO-69411.....	49
CS-45/2.....	38	MO-694M08.....	48	MO-68021.....	52	MO-68403.....	57	MO-69412.....	49
CZ-EV-RESC.....	45	MO-694M10.....	48	MO-68022.....	52	MO-68404.....	57	MO-69413.....	49
DX-02002.....	78	MO-694M12.....	48	MO-68023.....	52	MO-68405.....	57	MO-69414.....	49
DX-02003.....	77	MO-694M14.....	48	MO-68024.....	52	MO-68406.....	57	MO-69415.....	49
DX-02004.....	77	MO-694M17.....	48	MO-68025.....	52	MO-68408.....	57	MO-69416.....	49
DX-02006.....	78	MO-694M19.....	48	MO-68026.....	52	MO-68610.....	54	MO-69417.....	49
KIT-24.....	60	MO-698M03.....	48	MO-68027.....	52	MO-68613.....	54	MO-69418.....	49
KIT-RC-EPI-CO.....	41	MO-698M04.....	48	MO-68028.....	52	MO-68614.....	54	MO-69419.....	49
KIT-RC-PSA1.....	44	MO-698M05.....	48	MO-68029.....	52	MO-68620.....	54	MO-69421.....	49
KIT-RC-TOOL-3/8.....	43	MO-698M06.....	48	MO-68030.....	52	MO-68621.....	54	MO-69422.....	49
KIT-RC-TOOLS1.....	42	MO-698M07.....	48	MO-68032.....	52	MO-68713.....	54	MO-69423.....	49
KIT-RC-TST1.....	41	MO-698M08.....	48	MO-68106.....	52	MO-68714.....	54	MO-69424.....	49
KIT-VEH.....	80	MO-710-D.....	61	MO-68107.....	52	MO-68717.....	54	MO-69425.....	49

REFERENCES INDEX

Reference	Page	Reference	Page	Reference	Page	Reference	Page	Reference	Page
MO-69426.....	49	MO-72004.....	55	MO-682141.....	52	MP-11/26.....	35	MP-635/50-D.....	33
MO-69427.....	49	MO-72005.....	55	MO-682151.....	52	MP-11/66.....	35	MP-635/60-D.....	33
MO-69428.....	49	MO-72006.....	55	MO-682161.....	52	MP-29/2-S.....	32	MS-124/2.....	24
MO-69429.....	49	MO-72008.....	55	MO-682171.....	52	MP-29/3-S.....	32	MS-415.....	74
MO-69430.....	49	MO-72010.....	55	MO-682181.....	52	MP-35.....	31	MS-917-L.....	74
MO-69432.....	49	MO-72030.....	56	MO-682191.....	52	MP-35/12.....	31	MS-918-L.....	74
MO-69512.....	47	MO-72032.....	56	MO-682211.....	52	MP-37.....	31	MS-8013.....	75
MO-69513.....	51	MO-72034.....	56	MO-682221.....	52	MP-40.....	31	MS-8014.....	75
MO-69522.....	47	MO-72036.....	56	MO-682231.....	52	MP-60/02-5.....	35	MV-99-INSD.....	34
MO-69522V.....	53	MO-72038.....	56	MO-693100.....	48	MP-60/02-10.....	35	MV-136J-*.....	29
MO-69523.....	51	MO-72040.....	56	MO-698055.....	49	MP-100/02-5.....	35	MV-138-*.....	29
MO-69536.....	47	MO-72042.....	56	MO-720510.....	57	MP-100/02-10.....	35	MV-222-*.....	28
MO-69537.....	47	MO-72042.....	60	MO-720515.....	57	MP-120/02-5.....	35	MV-223-*.....	28
MO-69540.....	47	MO-72044.....	56	MO-720520.....	57	MP-120/02-10.....	35	MV-226-*.....	28
MO-69804.....	49	MO-72046.....	56	MO-720525.....	57	MP-123.....	30	MV-227-*.....	28
MO-69805.....	49	MO-72048.....	56	MO-720527.....	57	MP-123/1.....	30	MX-701.....	76
MO-69806.....	49	MO-72056.....	57	MO-720530.....	57	MP-123/2.....	30	MX-704.....	77
MO-69807.....	49	MO-72057.....	57	MO-720540.....	57	MP-220.....	30	PL-100.....	72
MO-69808.....	49	MO-72058.....	57	MO-720545.....	57	MP-220/1.....	30	PL-101.....	72
MO-69809.....	49	MO-72059.....	57	MO-720550.....	57	MP-625-D.....	33	PL-102.....	73
MO-69810.....	49	MO-72142.....	60	MO-RC-EV1.....	40	MP-627-D.....	33	PM-4-38-R-Z.....	71
MO-69811.....	49	MO-72172.....	60	MP-01.....	36	MP-635/10-D.....	33	PM-6-38-R-Z.....	71
MO-69812.....	49	MO-72200.....	60	MP-02.....	36	MP-635/15-D.....	33	PP-4-38-R-Z (*).....	71
MO-69813.....	49	MO-682101.....	52	MP-11/11.....	35	MP-635/20-D.....	33	PP-6-38-R-Z.....	71
MO-69814.....	49	MO-682111.....	52	MP-11/16.....	35	MP-635/25-D.....	33	SL-101.....	70
MO-72002.....	55	MO-682121.....	52	MP-11/21.....	35	MP-635/30-D.....	33	SL-102.....	70
MO-72003.....	55	MO-682131.....	52	MP-11/22.....	35	MP-635/40-D.....	33	SL-106.....	70



PPE / CPE
EYE PROTECTION

EN 166 / EN 170



MO-11000



MO-11001

SAFETY GLASSES

Use:

- Ensure the eyes protection against the impact of high-speed solid particles.
- Not adapted for welding operations.

Features:

- “Soft-flex” ear pieces guaranteeing low pressure fit.
- Delivered in a pouch.

Reference	Color	Resistance	
MO-11000	Transparent	Level F	24
MO-11001	Tinted	Level F	24



DELIVERED IN POUCH

EN 166 / EN 170



MO-11010

SAFETY OVER GLASSES

Use:

- Ensure the protection of the eyes against the impact of high-speed solid particles.

Features:

- Fit over prescription eye glasses.
- Delivered in a pouch.

Reference	Color	Resistance	
MO-11010	Transparent	Level F	45



MO-286

ARG-FLASH FACE SHIELD WITH HEADBAND

Use:

- Protective face shield against short-circuit electric arcs.
- To wear without helmet.
- Head adjustment by a ratchet.

Features:

- Anti-scratch and anti-fogging treatments.
- Screen height: 20,5 cm.

Reference



mm.



MO-286

270 x 260 x 200

0,40



MO-185-BL

ELECTRICIAN HELMET WITH INTEGRATED FACE SHIELD

Application :

- Head protection : mechanical protection and insulating protection in case of contact with live parts.
- Face protection against heat hazard of an arc flash APC1.

Features :

- Arc flash face shield totally retractable inside the helmet. Height of the screen 18 cm.
- Anti-scratch and anti-fogging face shield.
- Adjustable head band thanks to the ratchet.

Reference



mm.



MO-185-BL

340 x 270 x 190

0,75



HEADLAMP



MS-124/2

Application:

- Headlamp for helmets MO-185, MO-180-ARC and MO-182/1.
- Compatible with most of the helmets on the market.

Features:

- 3 lighting mode: Max, Mini and flashing signal.
- Orientable.
- Large autonomy: 100 hours in full power.
- Light distance at full power: 35 m.
- Maximum light output: 70 lm
- Supplied with support to fix on helmet: 1 universal adhesive.

Reference	Characteristics	Protection index	 g
MS-124/2	Waterproof	IPX4	68

PROTECTIVE COVERS FOR HELMETS AND VISORS



M-87384

Reference	Description	 mm.
M-87384	To protect helmet (or visor) during transport	Ø 435 (aperture) x 440



CG-00-R-28

ELECTRICAL INSULATING GLOVES: 28 CM

- Wellfit finish: soft, supple, resistant and ergonomic with high flexibility for an easy daily work.
- Insulating gloves adapted for Electric and Hybrid Vehicles operations: Arc-Flash protection ATPV 6 cal / cm², APC 1, class 00. Battery acid resistance.

Reference	Class		 (mm)	Colour	Sizes
CG-00-* -R-28	00	750 V DC	280		07-12
CG-0-* -R-28	0	1 500 V DC	280		07-12



To be used with **CG-981**
EXTRA-MECHANICAL
PROTECTION



ELECTRICAL INSULATING GLOVES: 36 CM

- Wellfit finish: soft, supple, resistant and ergonomic with high flexibility for an easy daily work.

Reference	Class		 (mm)	Colour	Sizes
CG-10	0	1 500 V DC	360 mm		07-12



CG-10..





MECHANICAL AND ARC FLASH INSULATING GLOVES: 36 CM



CGM-0..

- Electrical insulating gloves with mechanical resistance.
- Wellfit finish: soft, supple, durable and ergonomic with high flexibility to ease the work.
- Protection against thermal hazards from an electric arc ATPV 12 cal/cm², APC 2 (box test 7 kA) as a standard.

Reference	Class		 (mm)	Colour	Sizes
CGM-0	0	1 500 V DC	360 mm		07-12



EN 388:2016 / EN 420 +A1:5 / EN 407:2004



LEATHER OVERGLOVES FOR LOW VOLTAGE INSULATING GLOVES



CG-981...

Application:

- The overgloves ensure mechanical protection for insulating gloves (class 00 & 0).
- Resistant to flame and contact heat of 100 ° C for 10 s according to EN 407.
- Velcro® at the cuff adjusts the tightness of the glove to the user's hand.

Reference	Sizes	
CG-981-*	08-11	140

* Reference to be completed by size



CG-80-H

UNDERGLOVES FOR INSULATING GLOVES

- Application:**
- Washable undergloves improve the comfort of use and hygiene of insulating gloves.
- Composition:**
- Packaging : 5 pairs per plastic bag with an instruction for use.

Reference	Sizes	
CG-80-*	H = Man F = Woman	28

* Reference must be completed with H (Male model) or F (Female model)



CG-117

PNEUMATIC TESTER FOR INSULATING GLOVES

- Application:**
- For compulsory control of insulating gloves before use.
 - Device recommended by standard IEC 60903:2014 for the periodic testing of insulating gloves from class 00 to 4

Reference	Description	
CG-117	Pneumatic tester for insulating gloves	700





CG-35-2

CG-36-1

GLOVES BOX AND BAG FOR INSULATING GLOVES

- Application:**
- Ensure to the gloves a good mechanical protection against shocks and UV radiation.
 - Box can be fixed on a wall, in a substation, or be used as a carrying box and a storage box.

Reference	Composition	 mm	
CG-35-2	Box	476 x 224 x 101	900
CG-36-1	Bag	420 x 180 x 50	180



SAFETY SHOES WITH INSULATING SOLE, LEATHER TYPE



MV-222-*

Application:

- Safety shoes, leather type, conform to ASTM F2413:2018 Electrical Hazard resistance 18 kV.
- Water proof shoes fitting a wet atmosphere.
- Safety shoes with insulating sole specifically designed for the electricians, industry, building , oily and smooth soils.
- Individually tested (dielectric test).

Reference	Class	Size
MV-222-*	0	39 - 47
MV-223-*	0	39 - 47

* Complete the reference with the size. Ex: MV-222-43



MV-223-*



SAFETY SHOES WITH INSULATING SOLE, TEXTILE TYPE



MV-226-*

Application:

- Safety shoes, textile type, Conform to ASTM F2413:2018 Electrical Hazard resistance 18 kV.
- Water proof shoes fitting a wet atmosphere.
- Safety shoes with insulating sole specifically designed for the electricians, industry, building, oily and smooth soils.
- Individually tested (dielectric test).

Reference	Class	Size
MV-226-*	0	40-47
MV-227-*	0	40-47

* Complete the reference with the size. Ex: MV-227-43



MV-227-*



CE 0120 / EN ISO 20345
EN 50321-1:2018, ASTM F2413-05,
ASTM F1117-93 and CSA Z195-02



MV-136J...

INSULATING BOOTS CLASS 0 (1 000 V AC), TESTED 5 KV

Application :

- Insulating boots provide electrical insulating protection against step voltage.
- Class 0, 1 000 V AC / 1 500 V DC.
- Design to prevent clogging.

Reference	Class	Size
MV-136J-*	0	39-49

* Complete the reference with the size. Ex: MV-136J-43

EN 50321-1:2018
ASTM 1117



MV-138..

INSULATING OVERBOOTS CLASS 1 (7 500 V AC), 10 KV TESTED

Application:

- The overboots offer an electric insulation protecting the operator against the risks of step voltage on the ground or a current circulating between the feet and the ground.
- Ideal for temporary and frequent use.
- Fit perfectly over safety shoes allowing live working up to 7.5 kV AC with every boot tested to 10 kV AC.
- Rubber sole promoting a superior slip resistance.

Reference	Size
MV-138-*	M (39-42) L (43-45) XL (46-49)

* Complete the reference with the size. Ex: MV-138-L



MP-123



INSULATING BLANKET CLASS 0

Application:

- Used as protection for workers operating on live parts or in the vicinity of live parts.
- Operating voltage: 1 000 V AC - 1 500 V DC.

Features:

- In accordance with IEC 61112 class 0 standard and the specific properties:
 - Category A : Acid resistance.
 - Category C : Resistance to bending at very low temperature (-40°C).
 - Category H : Oil resistance.
- Fibers reinforced PVC material.
- Gripping tape (Velcro® type) all around the blanket for fixation or fitting with another blanket.
- Operating temperature range : -40°C to +55°C.
- High puncture resistance.

Reference	Class	mm.	Thickness mm	g
MP-123	0	360 x 660	0.5	160
MP-123/1	0	500 x 900	0.5	270
MP-123/2	0	800 x 1 200	0.5	570



ORANGE INSULATING BLANKET CLASS 0

Application:

- Used as protection for workers operating on live parts or in the vicinity of live parts.
- Operating voltage: 1 000 V AC - 1 500 V DC.

Features:

- In accordance with IEC 61112 class 0 standard and the specific properties:
 - Category C : Resistance to bending at very low temperature (-40°C).
 - Category H : Oil resistance.
- Orange elastomeric material.
- Operating temperature range : -40°C to +55°C.
- High puncture resistance.



MP-220

Reference	Class	mm.	Thickness mm	kg
MP-220	0	1 000 x 1 000	1.2	1.5
MP-220/1	0	1 000 x 10 000	1.2	15



INSULATING BLANKET CLASS 0



MP-37

Application:

- Insulating blanket for workers operating on live parts or in the vicinity of live parts.
- Operating voltage: 1 000 V AC - 1 500 V DC.

Features:

- In accordance with IEC 61112 class 0 standard and the specific properties:
 - Category A : Acid resistance.
 - Category C : Resistance to bending at very low temperature (-40°C).
 - Category H : Oil resistance.
 - Category Z : Ozone resistance.
- Operating temperature range : -40°C to +55°C.

Reference	Class	mm.	Thickness mm	kg
MP-35	0	1 300 x 25 000	0.3	12
MP-35/12	0	1 300 x 12 500	0.3	6
MP-37	0	90 x 25 000	0.3	0.8



MP-40



INSULATING BLANKET

Application:

- Operating voltage: 1 000 V AC - 1 500 V DC
- Used as protection for workers operating on live parts or in the vicinity of live parts.

Features:

- In accordance with SERECT ST HTA 50D standard.
- Translucent flexible plastic material.

Reference	mm.	Thickness mm	kg
MP-40	1 300 x 25 000	0.8	24



INSULATING BAG



MP-29/2-S





MP-29/3-S

Application:

- Insulating bag for live working on low voltage network or installation.
- They are used to cover live parts as connectors on cable ends.
- Maximum operating voltages: 1 000 V AC - 1 500 V DC.

Features:

- In accordance with NF C 18-425 standard and SERECT TST BT N°455 specification.
- Flexible thermoplastic material.
- Waterproof on 3 sides. Closing by strap “Velcro” type on the open side.
- Hole at the base of the bag for gripping with hook pole in the case of distance method working.
- 2 sizes available.

Reference	Material	 mm.	 g
MP-29/2-S	PVC	215 x 136	100
MP-29/3-S	PVC	225 x 305	160



MP-625-D



CLAMP FOR INSULATING BLANKET

Application:

- Insulating clamp for LV blankets fixation.

Features :

- Compliant with DIN VDE 0680-1 standard.
- Maximum operating voltage: 1 000 V AC - 1 500 V DC.
- Entirely insulating.
- Non-slip nose.

Reference	←→ mm.		
MP-625-D	165	1	70
MP-627-D	80	3	30



MP-627-D



MP-635/30-D



INSULATING CAP CLASS 0

Application :

- The insulating caps are used for temporary insulation of LV cable bare extremities.

Features :

- Maximum operating voltage : 1 000 V AC - 1 500 V DC.

Reference	←→ mm		
MP-635/10-D	75	10 mm	10
MP-635/15-D	100	15 mm	15
MP-635/20-D	100	20 mm	20
MP-635/25-D	110	25 mm	30
MP-635/30-D	120	30 mm	40
MP-635/40-D	135	40 mm	55
MP-635/50-D	155	50 mm	65
MP-635/60-D	140	60 mm	105



ELASTOMER INSULATING APRON



MV-99-INSD

Application:

- Orange colored elastomer insulating apron used to insulate insufficiently insulated conductive parts during the work.

Features:

- The material is also in compliance with special properties:
 - Category A: acid-resistant.
 - Category C: can be folded at very low temperature (-40°C).
 - Category H: oil-resistant.
- High resistance to perforation.
- Adjustable belt strap with plastic lock.
- Insulator's height: 65 cm. Width: 50 cm.
- Thickness: 1.2 mm.

Reference



mm.

MV-99-INSD

1 500 V DC

650 x 500

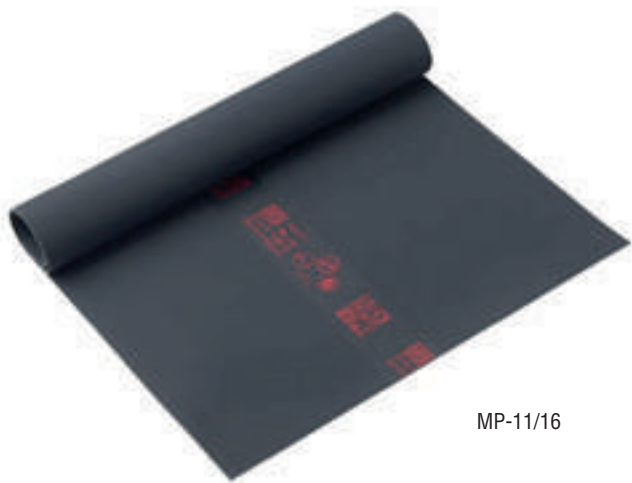
**INSULATING MAT CLASS 0 – WIDTH 1 M**



MP-11/16

Application :

- Operating voltage : 1 000 V AV - 1 500 V DC.
- Insulating mat for live line work and dead work.
- Floor covering for the electrical protection of workers in electrical installations.
- Protect the workers from the ground potential.

Features :

- In accordance with IEC 61111 standard and to specific properties of the “C” Category (extremely low temperature folding test at – 40 °C).
- RoHS2 and REACH compliant (SVHC free).
- D bar code (Datamatrix) on marking with direct link to user guide and technical sheet.
- Storage temperature: +10°C to +21°C.
- Operating temperature: -40°C to +55°C.

Reference	Class	 mm	 m	 kg
MP-11/66	0	2.2	0,6 x 0,6	1
MP-11/16	0	2.2	0,6 x 1	1,8
MP-11/26	0	2.2	0,6 x 1,2	2
MP-11/11	0	2.2	1 x 1	3
MP-11/21	0	2.2	1 x 1,2	3,4
MP-11/22	0	2.2	1,2 x 1,2	4
MP-60/02-5	0	2.2	0,6 x 5	9
MP-60/02-10	0	2.2	0,6 x 10	18
MP-100/02-5	0	2.2	1 x 5	15
MP-100/02-10	0	2.2	1 x 10	30
MP-120/02-5	0	2.2	1,2 x 5	17
MP-120/02-10	0	2.2	1,2 x 10	34



MO-160



MO-161



STRAP FOR INSULATING MATS

Application:

- Helps to keep the insulating mat in a rolled up position and facilitates storage.

Features:

- Instruction manual for insulating mat printed on the strap - pictograms and texts in French and English.

Reference	 mm.	 g
MO-160	530 x 38	100
MO-161	1 700 x 38	200



CARRYING BAG FOR BLANKETS AND INSULATING MATS

Application:

- Particularly suitable for transporting blankets and insulating mats.



MP-01

Reference	Use	 mm.	 kg
MP-01	For MP-11/16, MP-11/66, MP-11/26	700	0.35
MP-02	For MP-11/11, MP-11/21	1 230	0.42



IEC 61482-2 APC 1 & ATPV 12 cal/cm²
ISO 11612 A B1 C1 E2 F ISO 11611* classe 1
EN 1149-5 NFPA 70E - ASTM F1959



CAT'ARC MULTI-RISK CLOTHING TO PROTECT AGAINST AN ELECTRIC ARC

Application:

- Multi-risk protection: protection against thermal hazards of an electric arc, ATPV 12 cal / cm², APC 1, heat and flames, welding hazards and being antistatic.

Features:

- Hard-wearing garment: knees and crotch reinforcements.



AFG-2300-*

AFG-1001-*

Reference	Composition	Size
AFG-2000-*	Jacket	XS - 5XL
AFG-2001-*	Trousers	XS - 5XL
AFG-1001-*	Coverall	XS - 5XL
AFG-2300-*	Switching jacket	S, L, 2XL, 4XL

* Not concerned AFG-2300-*



Anti-panic zip to improve your safety in case of accident.



M-883374

PARKA “ARC FLASH”

Application:

- Multi-risk protection : protection against thermal hazards of an electric arc, heat and flame, rain protection, being anti-static, small splash of liquids chemicals, and high visibility.

Reference	Size
M-883374	S
M-883377	M
M-883378	L
M-883379	XL
M-883380	2XL
M-883381	3XL

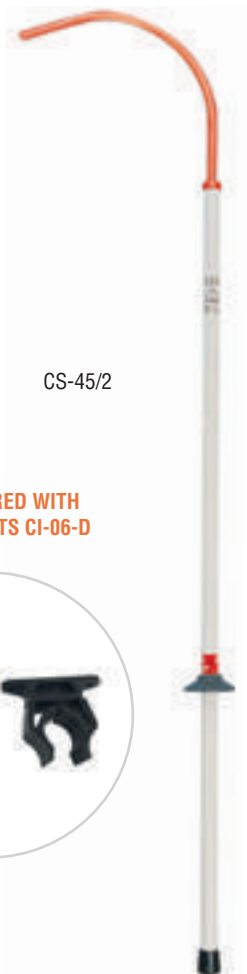

CS-45/2

STICK DELIVERED WITH WALL BRACKETS CI-06-D



RESCUE STICK WITH INSULATED HOOK NON REMOVABLE

Application:

- The rescue stick is suitable for use with a voltage of 45 kV or less.
- The rescue stick is used, in the context of an electric shock, to safely remove the dangerous elements from the accident area.
- Rescue stick is compliant with CATU STC n° 43.

Reference				
			(mm)	kg
CS-45/2	45 kV	67 kV	1 650	1



NEW!



CD-307

EXTINGUISHER FOR LI-ION BATTERY

Application:

- Portable fire extinguisher for Li-ion battery fire.
- Can be used on batteries with a maximum voltage of 1 000 V AC - 1 500 V DC.

Features:

- Fire class A.
- Liquid with aditif for li-ion batteries.
- Capacity: 3 liters.
- Limits the smoke formation.
- Maximum operating distance : 4 m.
- Duration of continuous spraying: 12 s.
- Service life 10 years.

Reference

 mm.

 kg

CD-307

410 x Ø 230

6



LIVE WORKING / DEAD WORKING ROLLER CABINET AND KITS



MO-RC-EV1



ROLLER CABINET FOR HYBRID AND ELECTRIC VEHICLE OPERATIONS

Application:

- Roller cabinet for hybrid and electric vehicle operations. Allows to store all the necessary equipment: PPE, locking - signaling equipment and insulated tools in one place.

Features:

- Maximum load: 850 kg (Static).
- ABS Tray with Metal board and ATP-551-B Sign: "HEV Golden Rules"
- 2 drawers: 74 mm height each
- 2 drawers: 132 mm height each
- 1 drawer: 272 mm height
- Storage for boundary posts (up to 6 units Ø 5 cm, not included)
- 4 wheels, 2 fixed and 2 steering with brake
- 100% steel epoxy painted

Reference



mm.



MO-RC-EV1

1 359 x 973 x 481

50

- To complement the roller cabinet, select the kit meeting your operation:



	Trade	Vehicle repair	Represent alive vehicle repair	MOT or technical control	Paint & body repair	Dealer	Training agency
Roller cabinet	MO-RC-EV1	•	•	•	•	•	•
Delineation Lock-Out Essential set for personal protection	KIT-RC-EPI-CO	•	•	•	•	•	•
Work in the vicinity or under voltage Insulating items	KIT-RC-TST1			•	•	•	•
Live working with essential tools	KIT-RC-TOOLS1					•	•
Live working with tools to improve your productivity	KIT-RC-TOOLS-3/8					•	•
Lock-Out for PSA vehicle (tools)	KIT-VEH-PPE/02	•		•	•		



PPE, LOCKING AND SIGNALING EQUIPMENT KIT

Application:

- PPE, locking and signaling equipment kit for all the maintenance operations on HEV.



KIT-RC-EPI-CO

Reference	Comp.	Quantity	Description
AL-323		4	Safety boundary posts
AL-31/25		25 m	Plastic chain delineators
MO-286		1	Arc-flash shield with bandhead
M-87-384		1	Protection bag for Arc-flash shield
CGM-0-10		1	Rubber insulating gloves with mechanical and Arc-Flash (ATPV 12 cal/cm ² , APC 2) protection, Size: 10, Class 0 (1 000 V AC - 1 500 V DC)
ACA-10		1	3-sided magnetic warning pyramid
AL-43		1	Textile red tape delimitators
MS-917-PG		1	Voltage detector. Operating range from 12 to 900 V AC and from 12 to 1 000 V DC
PP-4-38-RZ		1	Plastic padlock with a Ø 4 mm insulating nylon shackle



KITS FOR
ROLLER
CABINET

PROTECTIVE EQUIPMENT KIT FOR LIVE WORKING

Application:

- For live working operation at maximum voltage of 1 000 V AC – 1 500 V DC.
- For operator protection against live conductors and connectors.
- Kit also recommended for paint and body repair workshops and road assistance.



KIT-RC-TST1

Reference	Comp.	Quant.	Description
MP-220		1	Insulating blanket 1 m X 1 m, class 0
MP-627-D		4	Insulating clamps 80 mm for blanket
MP-635/30-D		3	Insulating caps Ø 30 X 120 mm, class 0
MP-635/60-D		3	Insulating cap Ø 40 X 135 mm, class 0



KITS FOR
ROLLER
CABINET

**NEW!**

KIT-RC-TOOLS1

**KIT OF 28 INSULATED TOOLS
IEC 60900:2018****Application:**

- Maximum operation voltage: 1 000 V AC – 1 500 V DC.
- Contains the insulated tools for live working operations on HEV. Supplied with a foam storage module with machined tool supplied.

Reference	Comp.	Quant.	Description
MO-65204		1	Insulated Flat blade screwdriver 3,5 X 100 mm, 1 000 V AC – 1 500 V DC, IEC 60900:2018
MO-65206		1	Insulated Flat blade screwdriver 5,5 X 100 mm, 1 000 V AC – 1 500 V DC, IEC 60900:2018
MO-65242		1	Insulated POZIDRIV screwdriver n°1, 4,5 X 80 mm, 1 000 V AC – 1 500 V DC, IEC 60900:2018
MO-65244		1	Insulated POZIDRIV screwdriver n°2, 6 X 100 mm, 1 000 V AC – 1 500 V DC, IEC 60900:2018
MO-65246		1	Insulated POZIDRIV screwdriver n°3, 8 X 150 mm, 1 000 V AC – 1 500 V DC, IEC 60900:2018
MO-66001		1	Insulated universal pliers 160 mm ,1 000 V AC – 1 500 V DC, IEC 60900:2018
MO-66402		1	Insulated bent nose pliers 160 mm, 1 000 V AC – 1 500 V DC, IEC 60900:2018
MO-66505		1	Insulated multigrip pliers 1 000 V AC – 1 500 V DC, IEC 60900:2018
MO-67102		1	Insulated cutting plier, 1 000 V AC – 1 500 V DC, IEC 60900:2018
MO-6990.		1	Insulated set of 6 bented male hexagonal wrenches from 3 mm to 8 mm, 1 000 V AC – 1 500 V DC, IEC 60900:2018
MO-680..		1	Insulated set of 5 open-end spanners size 8, 9, 10, 11 and 13 mm, 1 000 V AC – 1 500 V DC, IEC 60900:2018
MO-681..		1	Insulated set of 7 ring spanners size 8, 10, 11, 12, 13, 14 and 16 mm, 1 000 V AC – 1 500 V DC, IEC 60900:2018
MO-7582-D		1	Insulated magnet with flexible extension and handle 1 000 V AC – 1 500 V DC, IEC 60900:2018
MO-FT-01		1	Tool storage foam tray

KIT-RC-TOOLS1

**KITS FOR
ROLLER
CABINET**



KIT-RC-TOOLS-3/8

KIT OF 17 INSULATED 3/8" SQUARE DRIVE TOOLS IEC 60900:2018

Application:

- Maximum operation voltage: 1 000 V AC – 1 500 V DC.
3/8 " insulated tightening tool kit offering productivity and safety for live working on HEV and batteries.

Reference	Comp.	Quant.	Description
	MO-69513	1	Insulated 3/8" Ratchet wrench, length: 190 mm, 1 000 V AC – 1 500 V DC, IEC 60900:2018
	MO-69523, MO-69533	2	Insulated 3/8" 140 mm and 264 mm extension bar, 1 000 V AC – 1 500 V DC, IEC 60900:2018
KIT-RC-TOOL-3/8	MO693..	1	Insulated 3/8" 6 sided socket set, 1 000 V AC – 1 500 V DC, EC 60900:2018, Size: 8 mm to 16 mm
	MO6939.	1	Insulated 3/8" hexagonal male socket set 1 000 V AC – 1 500 V DC, IEC 60900:2018, Size: 4 mm to 8 mm
	MO-FT-02	1	Tool storage foam tray



KITS FOR
ROLLER
CABINET





KIT-RC-PSA1

KIT OF 13 INSULATED TOOLS 1 000 V AC – 1 500 V DC IEC 60900:2018

Application :

- For live working operation at maximum voltage of 1 000 V AC – 1 500 V DC.
- To Lock-Out PSA vehicles like the CITROEN C-Zero and Peugeot iOn.
- Including a tool storage foam tray.

Reference	Comp.	Quant.	Description
	MO-65206	1	Insulated flat screwdriver 5.5 X 100 mm 1 000 V AC – 1 500 V DC, IEC 60900:2018
	MO-65244	1	Insulated POZIDRIV screwdriver n°2, 6 X 100 mm, 1 000 V AC – 1 500 V DC, IEC 60900:2018
	MO-681..	2	Insulated offset wrenches 10 and 12 mm, 1 000 V AC – 1 500 V DC, IEC 60900:2018
KIT-RC-PSA1	MO-69513	1	Insulated 3/8" Ratchet wrench, length: 190 mm, 1 000 V AC – 1 500 V DC, IEC 60900:2018
	MO-69523, MO-69533	2	Insulated 3/8" 140 mm and 264 mm extension bar, 1 000 V AC – 1 500 V DC, IEC 60900:2018
	MO693..	1	Insulated 3/8" 6 sides socket set 1 000 V AC – 1 500 V DC, IEC 60900:2018, Size: 8, 10, 11, 12, 13 and 14 mm
	MO-FT-03	1	Tool storage foam tray

KITS FOR
ROLLER
CABINET



CZ-EV-RESC

RESCUE WALL KIT FOR AUTOMOTIVE MAINTENANCE AND BODY REPAIR SHOPS

Application:

- Rescue wall kit for automotive maintenance and body repair shops. For interventions in the event of an electrical hazard or fire.
- Wall support accessories included.

Reference	Comp.	Quant.	Description
	CS-45/2	1	Rescue stick with insulated hook
	CG-35-2	1	Wall box for insulating gloves
CZ-EV-RESC	CGM-0-10	1	Rubber insulating gloves with mechanical and Arc-Flash (ATPV 12 cal/cm ² , APC 2) protection, Size: 10, Class 0 (1 000 V AC - 1 500 V DC)
	CD-307	1	Fire extinguisher for this Li-ion battery



KITS FOR ROLLER CABINET





LIVE WORKING / DEAD WORKING INSULATED TOOLS



MO-810

Ultimate safety protection:
There is no electrical continuity between the 2 battery fixing
screws and the lifting ring



Adjustable 81 - 118 mm



INSULATING DEVICE TO LIFT UP BATTERY

Application:

- Insulated lifting device for LV live working.
- For batteries lifting during maintenance operations.

Features:

- Maximum operating voltages: 1 000 V AC - 1 500 V DC
- Lifting device in accordance with machinery directive 2006/42/CE.
- Electrically tested according IEC 60900 standard.
- Adjustable fixing capacity from 81 to 118 mm.

Reference

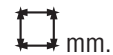

MO-810

160 x 130 x 50

0,6



Unscrew the first battery terminal and place the first insulated
plug in its place

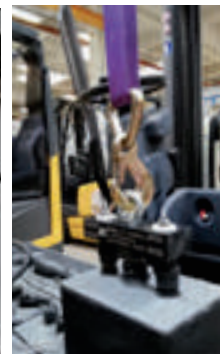

Unscrew the second battery terminal and place the second insulated
plug its place.



MO-69513
RATCHET WRENCH WITH
LOCKING SYSTEM



MO-69523
EXTENSION



MO-69543
«T» WRENCH



MO-69540
EXTENSION

RATCHETS AND ACCESSORIES

Square drive	1/4"	3/8"	1/2"
Ratchet	125 mm	190 mm	255 mm
	MO-69512	MO-69513	MO-69514
Extension	170 mm	130 mm	125 mm
	MO-69522	MO-69523	MO-69524
		250 mm	250 mm
		MO-69533	MO-69534
«T» wrench	-	130 mm	300 mm
		MO-69542	
		250 mm	
		MO-69543	MO-69544
Screwdriver handle	150 mm	-	-
	MO-69540		



EXPANDER FEMALE TO MALE

Application :

- Insulated expander for LV live working.

Features :

- Insulated with orange hardened PVC
- Maximum operating voltages: 1 000 V AC - 1 500 V DC.



MO-69537

Reference	Female square	Male square	↔ (mm)	⚖ g
MO-69537	1/4"	3/8"	54	30
MO-69536	3/8"	1/2"	75	40



MO-69025



MO-69050



MO-69051



MO-69054

ADJUSTABLE TORQUE WRENCH 3/8"

Application:

- Insulated adjustable torque wrench for LV live working.

Features:

- Maximum operating voltage: 1 000 V AC - 1 500 V DC.

Reference	↔ (mm)	F_{Nm}	
MO-69025	380	5 to 25	1.38
MO-69050	340	8 to 60	0.9
MO-69051	230	4 to 20	0.9
MO-69054	340	8 to 60	0.9



6 SIDES MALE SOCKET

	1/4"	3/8"	1/2"
3	MO-698M03	MO-69393	-
4	MO-698M04	MO-69394	MO-694M04
5	MO-698M05	MO-69395	MO-694M05
6	MO-698M06	MO-69396	MO-694M06
7	MO-698M07	MO-69397	-
8	MO-698M08	MO-69398	MO-694M08
10	-	MO-693100	MO-694M10
12	-	-	MO-694M12
14	-	-	MO-694M14
17	-	-	MO-694M17
19	-	-	MO-694M19



MO-698M03



6 - 12 SIDED INSULATING SOCKETS



MO-69408

	1/4"	3/8"	1/2"
4	MO-69804	-	-
5	MO-69805	-	-
5,5	MO-698055	-	-
6	MO-69806	MO-69306	-
7	MO-69807	MO-69307	-
8	MO-69808	MO-69308	MO-69408
9	MO-69809	MO-69309	MO-69409
10	MO-69810	MO-69310	MO-69410
11	MO-69811	MO-69311	MO-69411
12	MO-69812	MO-69312	MO-69412
13	MO-69813	MO-69313	MO-69413
14	MO-69814	MO-69314	MO-69414
15	-	MO-69315	MO-69415
16	-	MO-69316	MO-69416
17	-	MO-69317	MO-69417
18	-	MO-69318	MO-69418
19	-	MO-69319	MO-69419
21	-	MO-69321	MO-69421
22	-	MO-69322	MO-69422
23	-	MO-69323	MO-69423
24	-	MO-69324	MO-69424
25	-	-	MO-69425
26	-	-	MO-69426
27	-	-	MO-69427
28	-	-	MO-69428
29	-	-	MO-69429
30	-	-	MO-69430
32	-	-	MO-69432



3/8" TORX INSULATED SOCKET

Application:



- 3/8" TORX insulating socket for LV voltage live working.

Features:

- Maximum operating voltage: 1 000 V AC - 1 500 V DC.
- Orange PVC insulation.
- 3/8" square drive.
- 15 to 40 TORX, 50 RESISTORX.



MO-69T15

Reference		 (mm)
MO-69T15	Torx T15 ★	60
MO-69T20	Torx T20 ★	65
MO-69T25	Torx T25 ★	65
MO-69T30	Torx T30 ★	80
MO-69T40	Torx T40 ★	80
MO-69T50	Torx T50 ★	80



3/8" INSULATED TOOL SET



MO-69308/23

Application:

- Set of Insulated 3/8" tools for LV live working.

Features:

- Maximum operating voltage: 1 000 V AC - 1 500 V DC.
- Square drive 3/8".



Composition :

- 1 ratchet wrench 3/8" with mechanical locking MO-69513.
- 1 extension 3/8" length 140 mm MO-69523.
- 10 sockets 3/8" 6 sided from 8 to 23 mm.

Reference	Description	
MO-69308/23	3/8" socket wrench set with ratchet and extension in polypropylene case 410 x 120 x 75 mm	1.45 kg



MO-69314

Reference		
MO-69308	8 mm	0.03
MO-69310	10 mm	0.03
MO-69312	12 mm	0.033
MO-69313	13 mm	0.036
MO-69314	14 mm	0.042
MO-69317	17 mm	0.06
MO-69319	19 mm	0.69
MO-69321	21 mm	0.08
MO-69322	22 mm	0.095
MO-69323	23 mm	0.1
MO-69513	Ratchet	0.45
MO-69523	140 mm extension	0.12





WRENCHES AND SPANNERS







MO-68006
OPEN JAW SPANNER



MO-68106
DEEP OFFSET WRENCH



MO-68206
PIPE WRENCH

 mm	Open jaw spanner	Deep offset wrench 	Pipe wrench	
6	MO-68006	MO-68106	MO-68206	
7	MO-68007	MO-68107	MO-68207	
8	MO-68008	MO-68108	MO-68208	
9	MO-68009	MO-68109	MO-68209	
10	MO-68010	MO-68110	MO-68210	
11	MO-68011	MO-68111	MO-68211	
12	MO-68012	MO-68112	MO-68212	
13	MO-68013	MO-68113	MO-68213	
14	MO-68014	MO-68114	MO-68214	
15	MO-68015	MO-68115	MO-68215	
16	MO-68016	MO-68116	MO-68216	
17	MO-68017	MO-68117	MO-68217	
18	MO-68018	MO-68118	MO-68218	
19	MO-68019	MO-68119	MO-68219	
20	MO-68020	MO-68120	-	-
21	MO-68021	MO-68121	MO-68221	
22	MO-68022	MO-68122	MO-68222	
23	MO-68023	MO-68123	MO-68223	
24	MO-68024	MO-68124	-	-
25	MO-68025	MO-68125	-	-
26	MO-68026	MO-68126	-	-
27	MO-68027	MO-68127	-	-
28	MO-68028	MO-68128	-	-
29	MO-68029	MO-68129	-	-
30	MO-68030	MO-68130	-	-
32	MO-68032	MO-68132	-	-



MO-69522V



INSULATING ADAPTOR

Application:

- Insulating adaptor, with 1/4" hexagonal male fitting and 3/8" square drive.
- For use with electric screwdriver.

Features :

- Operating voltage up to 1 000 V AC - 1 500 V DC.
- In accordance with IEC 60900 standard.
- No electrical continuity between the 1/4" fitting, and the 3/8" square drive for fitting on sockets.
- Maximum torque : 40 Nm.
- Fitting 1/4" male, hexagonal, on one side, for electric screwdriver. Length 20 mm.
- Square drive 3/8" male, on the other side, for mounting with 3/8" sockets.
- Maximum diameter on insulation: 20.5 mm.

Reference

(mm)



MO-69522V

80

66



MO-69210

INSULATED RATCHET WRENCH

Application:

- Insulated ratchet wrench for LV live working.

Features:

- Maximum operating voltage: 1 000 V AC - 1 500 V DC.



Reference

mm



10

MO-69210

9

0.29

13

MO-69213

11

0.45

17

MO-69217

16

0.55

19

MO-69219

18

0.70



INSULATED CABLE CUTTER



MO-67501

Application:

- Insulated cable cutter for LV live working.

Features:

- Maximum operating voltage: 1 000 V AC - 1 500 V DC.
- Orange hardened PVC insulation.
- Special steel body.

Reference	↔ (mm)	∅	g
MO-67501	170	15	250
MO-67502	230	20	450



T-HANDLE WRENCH

Application:

- T-Handle wrench for LV live working.

Features:

- Maximum operating voltage : 1 000 V AC - 1 500 V DC.
- 6 sided hexagonal female spanner.



MO-68310

↔ ∅	Length 140 mm	Length 300 mm	Length 400 mm
10	MO-68610	MO-68310	-
11	-	MO-68311	-
12	-	MO-68312	-
13	MO-68613	MO-68313	MO-68713
14	MO-68614	MO-68314	MO-68714
16	-	MO-68316	-
17	-	MO-68317	MO-68717
19	-	MO-68319	-
20	MO-68620	-	-
21	MO-68621	MO-68321	-
22	-	MO-68322	-



ADJUSTABLE WRENCH



MO-69003

Application:

- Insulated adjustable wrench for LV live working.

Features:

- Maximum operating voltage: 1 000 V AC - 1 500 V DC.

Reference	Opening (mm)	↔ (mm)
MO-69003	28 mm	250
MO-69005	43 mm	390



INSULATED BI-MATERIAL FLAT BLADE SCREWDRIVER



MO-72002

Application:

- Insulated screwdriver for LV live working.

Features:

- Maximum operating voltages: 1 000 V AC - 1 500 V DC.
In accordance with DIN 5262 and ISO 8764 standards.

Reference	Description	□ mm.
MO-72002	Insulated slotted screwdriver 2.5 x 60 mm.	2.5 x 60
MO-72003	Insulated slotted screwdriver 3 x 100 mm.	3 x 100
MO-72004	Insulated slotted screwdriver 4 x 125 mm.	4 x 125
MO-72005	Insulated slotted screwdriver 5 x 150 mm.	5 x 150
MO-72006	Insulated slotted screwdriver 6 x 150 mm.	6 x 150
MO-72008	Insulated slotted screwdriver 8 x 175 mm.	8 x 175
MO-72010	Insulated slotted screwdriver 10 x 200 mm.	10 x 200



INSULATED BI-MATERIAL POZIDRIV SCREWDRIVER



MO-72040

Application:

- Insulated screwdriver for LV live working.

Features:

- Maximum operating voltages: 1 000 V AC - 1 500 V DC.
- In accordance with DIN 5262 and ISO 8764 standards.

Reference	Description
MO-72040	PZ 0
MO-72042	PZ 1
MO-72044	PZ 2
MO-72046	PZ 3
MO-72048	PZ 4



INSULATED BI-MATERIAL PHILLIPS SCREWDRIVER



MO-72030

Application:

- Insulated screwdriver for LV live working.

Features:

- Maximum operating voltages: 1 000 V AC - 1 500 V DC.
- In accordance with DIN 5262 and ISO 8764 standards.

Reference	Description
MO-72030	PH 0
MO-72032	PH 1
MO-72034	PH 2
MO-72036	PH 3
MO-72038	PH 4



INSULATED BI-MATERIAL HEXAGONAL SCREWDRIVER



MO-68402

Application:

- Insulated screwdriver for LV live working.

Features:

- Maximum operating voltages: 1 000 V AC - 1 500 V DC.
- In accordance with DIN 5262 and ISO 8764 standards.

Reference	Description
MO-68402	2.5 mm X 75 mm length
MO-68403	3 mm X 75 mm length
MO-68404	4 mm X 100 mm length
MO-68405	5 mm X 100 mm length
MO-68406	6 mm X 125 mm length
MO-68408	8 mm X 150 mm length



INSULATED BI-MATERIAL TORX SCREWDRIVER



MO-720510

Application:

- Insulated screwdriver for LV live working.

Features:

- Maximum operating voltages: 1 000 V AC - 1 500 V DC.
- In accordance with DIN 5262 and ISO 8764 standards.

Reference	Description
MO-72056	TORX T6 x 50 mm
MO-72057	TORX T7 x 50 mm
MO-72058	TORX T8 x 50 mm
MO-72059	TORX T9 x 75 mm
MO-720510	TORX T10 x 75 mm
MO-720515	TORX T15 x 75 mm
MO-720520	TORX T20 x 100 mm
MO-720525	TORX T25 x 100 mm
MO-720527	TORX T27 x 115 mm
MO-720530	TORX T30 x 125 mm
MO-720540	TORX T40 x 125 mm
MO-720545	TORX T45 x 150 mm
MO-720550	TORX T50 x 175 mm



INSULATION TORQUE SCREWDRIVER



MO-7200DYN

Application:

- Low voltage live working.
- Controlled torque tightening.

Features:

- Maximum operating voltage: 1 000 V AC - 1 500 V DC.
- Torque range: 0.8 to 5 Nm
- Accuracy: $\pm 6\%$.
- Bits locking system.
- Including a calibration tools and a calibration certificate.
- Bits not including.

Reference	\vec{F}_{Nm}	\longleftrightarrow (mm)	 g
MO-7200DYN	0.8 to 5	190	290



INSULATED BITS FOR MO-7200-DYN TORQUE SCREWDRIVER



MO-7200-PH2



MO-7200-PZ1



MO-7200-PZ2



MO-7200-SL4



MO-7200-SL55

Application:

- For live working on low voltage.
- To be only used with the MO-7200-DYN.

Features:

- Operating voltage: 1 000 V AC - 1 500 V DC.

Reference	Description	\longleftrightarrow (mm)	 g
MO-7200-PH2	PHILLIPS PH2	75	30
MO-7200-PZ1	POZIDRIV PZ1	75	30
MO-7200-PZ2	POZIDRIV PZ2	75	30
MO-7200-SL25	FLAT BLADE 2.5 mm	75	25
MO-7200-SL4	FLAT BLADE 4 mm	75	30
MO-7200-SL55	FLAT BLADE 5.5 mm	75	35
MO-7200-T15	TORX T15	75	25
MO-7200-T20	TORX T20	75	30
MO-7200-T25	TORX T25	75	35



MO-66000C

INSULATING PLIERS

- Application:**
- Insulating bent nose pliers for live working at low voltage.
- Features:**
- Maximum operating voltage: 1 000 V AC - 1 500 V DC.
 - Fully insulating orange composite material.
 - Ceramic cutters.



MO-66303C



MO-66404CC

Reference	Description	↔ (mm)	 g
MO-66000C	Universal plier	200	150
MO-66303C	Flat nose plier	190	110
MO-66404CC	Bent flat nose plier	210	150

**BI-MATERIAL INSULATED TOOLS KIT****Application:**

- Insulated tools for LV live working.

Features:

- Maximum operating voltage : 1 000 V AC - 1 500 V DC.

Composition:

- 3 flat blade screwdrivers: MO-72004 (4x125 mm) - MO-72006 (6x150 mm) - MO-72008 (8x175 mm).
- 2 Pozidriv screwdrivers: PZ1 MO-72042 - PZ2 MO-72044.
- 1 wire stripping pliers MO-72172.
- 1 bent snipe nose pliers MO-72142.
- 1 cable cutter pliers MO-72200.



KIT-24

Reference	Composition	Description
KIT-24	MO-72004	Flat blade 4 x 125 mm
	MO-72006	Flat blade 6 x 150 mm
	MO-72008	Flat blade 8 x 175 mm
	MO-72042	POZIDRIV screwdriver N ° 1
	MO-72044	POZIDRIV screwdriver N ° 2
	MO-72172	End stripping pliers 160 mm
	MO-72142	Bent snipe nose pliers 160 mm
	MO-72200	Cable cutter 160 mm

**MAGNET ON FLEXIBLE HANDLE****Application:**

- Magnet on flexible handle for LV live working.

Features:

- Operating voltage up to : 1 000 V AC - 1 500 V DC.
- Entirely insulated.
- Magnet diameter : 14,5 mm.
- Maximum load to the magnet : 1 kg.



MO-7582-D

Reference	↔ (mm)	⚖ g
MO-7582-D	470	200



MO-745D

INSULATED DEAD-BLOW HAMMER

Application:

- Insulated hammer for LV live working.

Features:

- In accordance with IEC 60900 standard.
- Maximum operating voltage up to : 1 000 V AC - 1 500 V DC.
- 2 interchangeable insulated striking head of diameter 35 mm.
- Dead-blow system.

Reference



(mm)



MO-745D

310 x 120 x 40

800



MO-755D

INSULATED MIRROR

Application:

- Insulated mirror for LV live working.

Features:

- Maximum operating voltage : 1 000 V AC - 1 500 V DC.
- Mirror diameter : 22 mm.

Reference



MO-755D

22 mm

20



MO-710D

INSULATING BRUSH

Application:

- Insulated brush for LV live working.

Features:

- Maximum operating voltage : 1 000 V AC - 1 500 V DC.

Reference



mm.



MO-710-D

420 x 38

80



MO-61001



MO-61002



INSULATED KNIVES

Application:

- Insulated knives for LV live working.

Features:

- Maximum operating voltage: 1 000 V AC - 1 500 V DC.
- Grey insulating material with SOFT touch on the handle.

Reference	← (mm)	 mm	
MO-61001	180	62	100
MO-61002	180	50	100



ELECTRICIAN TOOL BAG

Application:

- Bag to carry/store tools, accessories, etc.



M-87303

Reference	 mm.	
M-87303	440 x 330 x 160	0,82

TEXTILE TOOL BOX

Application:



- Tool box to carry/store tools, accessories, etc.

Features:

- 1 removable partition.16 pockets for tools.
- 9 storage pockets for tools on the external side of the tool box.
- Rubber reinforcements on the bottom.



MO-39

Reference	 mm.	
MO-39	480 x 320 x 230	0.9





M-882452

STORAGE BOXES FOR ACCESSORIES AND TOOLS

Application:

- To store, stock or transport material.

Reference	 mm.	 kg
M-882452	500 x 280 x 250	1,1

TOOL BAG WITH REINFORCED BASE

Application:



- Bag to carry/store tools, accessories, etc.

Features:

- Metal wire framing structure, allowing an immediate access to the bag content.
- Numerous interior and exterior pockets for a high storage capacity.
- Zip closure with metal slider.
- Rigid plastic abrasion-resistant bottom and ensuring great stability of the bag in the open position.



MO-42/1

Referene	 mm.	 kg
MO-42/1	320 x 240 x 170	0,70
MO-42/2	400 x 270 x 220	0,80



MO-44

BACKPACK WITH WHEELS FOR ELECTRICIAN



Application:

- Ergonomic wheeled backpack, reducing musculoskeletal disorders (MSD).
- Perfectly fitted for transport and storage of the tool kits, laptop and helmet.
- Provides 3 modes of carrying: hand, wheels or back.

Features:

- Ergonomic foamed shoulder straps, with possibility to store them in a special pocket for not dragging on the ground.
- Foam-filled protection reinforcements for a better back and lumbar comfort.
- High-strength and silence-proof wheels – non replaceable.
- Telescopic adjustable handle 2 heights.



Reference	 mm.	 kg	Volume
MO-44	460 x 330 x 240	3,2	30 L



SIGNS / LOCK-OUT / TAG-OUT REGULATORY SIGNS

ACA-10



MAGNETIC SIGNAL PYRAMID “ELECTRIC HAZARD” TO WORK ON EHV OR BATTERIES

Application:

- Positioned on the roof of an electric vehicle or on metallic part, it allows an optimum 360° visualization of the electric danger.

Features:

- Installation and removal made easy thanks to the magnetic base with strong adhesion in a triangular shape (140 mm side).
- Delivered flat (pattern): the user easily assembles the sides, thanks to adhesive strips already placed on the product.

Reference



mm.

ACA-10

When the structure is not assembled:
side 350 mm. Assembled triangular face frame:
170 mm side.



AP-550-M2V

PLASTIC POSTER FOR HEV

Reference



mm.

Use

AP-550-M2V

150 x 450 x 4

Suction cups

AP-550-M3

150 x 450 x 4

Magnetic support

AP-72

150 x 450 x 4

Support for boundary post



AP-550-M3



AP-72



SET OF 40 TEMPORARY STICKERS « DAMAGED VEHICLE » FOR HEV



AT-81

Application:

- Temporary sticker to place on the windows or the windscreen of the damaged electric and hybrid vehicles.
- Helps to keep people informed of the danger.
- Easy to remove after the towing and the repair of the vehicles.

Reference



mm.



AT-81

280 x 110

40

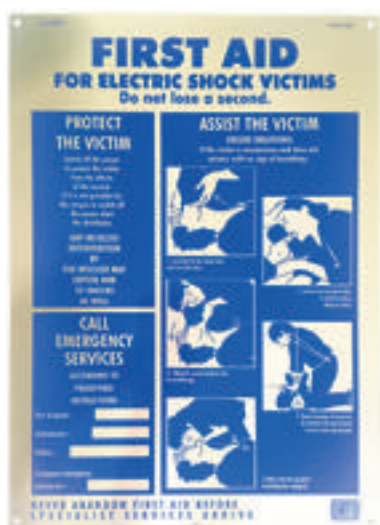

AM-20-B

ALUMETAL™ WARNING SIGN

Reference



Holes

Num.
Holes



mm.

AM-20 GB

Diam. 4.5 mm

4

500 x 350 x 1



ATP-551-B

ADHESIVE PLASTIC POSTER FOR HEV A4 FORMAT

Application :

- Signal of the safety rules for operation on electrical or hybrid vehicle.

Features :

- Hanging with adhesive strips included or mounting holes.

Reference



mm.

ATP-551-B

210 x 297 x 1



FOLDING SAFETY BARRIER



AL-326

Application:

- Allows temporarily delineation of a working area.
- For indoor use.

Features:

- Modularity: possibility to add or remove panels.
- Highly visible with the fluorescent yellow colour.

Reference	mm.	kg
AL-325	3 panels : 1710 x 1000	3,2
AL-326	1 panel (extension) : 570 x 1000	1,4



AL-325

BOUNDARY POST FOR DELINEATION OF A WORKING AREA

Application :

- Boundary post enables delineation and signaling of a working area.
- Outdoor and indoor use.
- Can be completed with AL-3...-chain.



AL-316



AL-318



AL-323



AL-324



AL-328

Reference	Composition	mm.	kg
AL-316	Foldable. Ballasted base.	Post : Ø 50 x 900 Base : 280 x 280 x 70	4
AL-318	Foldable. Ballasted base.	Post : Ø 50 x 900 Base : 280 x 280 x 70	4
AL-323	Ballasted base.	Post : Ø 50 x 900 Base : 280 x 280 x 50	2,9
AL-324	Ballasted base.	Post : Ø 50 x 900 Base : 280 x 280 x 50	2,9
AL-328	With retractable strap. Ballasted base.	Total height 1 m Tape: 1 50 mm x L 4 m	8



AL-31/25



AL-32/25

PLASTIC CHAIN

Application:

- For any signaling or delineation operation.
- To be completed with AL-3...-post.

Features:

- Chain with plastic openable links.
- Chain link diameter: 8 mm.
- Chain link dimensions: 70 x 27 mm.

Reference	Composition	↔ (mm)	Color	kg
AL-31/05	chain links	5000		0,55
AL-31/25	chain	25000		2,5
AL-32/05	chain	5000		0,55
AL-32/25	chain	25000		2,5
AL-31	5 red & 5 white chain links	52		0,05





Adhesive



AT-5005



AL-139

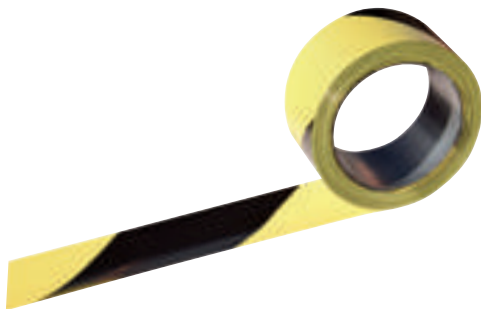



AL-140

SIGNALING / DELINEATION TAPE

Application:

- Allows temporarily delineation of a working area.
- For indoor and outdoor use.

Reference	Color	Marking	Description
AT-5005		Oblique bands	Adhesive tape 100 x 50 m
AL-139		Oblique bands	Plastic edge tape 100 m x 50 mm.
AL-140		Oblique bands	Plastic edge tape 100 m x 50 mm.



LOCKING

LOCK-OUT / TAG-OUT



SL-101



SL-102



LOCKOUT STATION

Application:

- Allows the storage of the lockouts.

Features:

- Transparent door.
- Locked by key.
- Delivered without padlock or lockout.

Reference	Colour		 mm.	 kg
SL-101	Yellow	-	405 x 355 x 156	5,6
SL-102	Red	42	465 x 395 x 55	4,5



SL-106



GROUP LOCK BOX

Application:

- Device for storing the keys of safety padlocks.
- Prevents unintentional re-energization while operators are working on the equipment.

Features:

- 12 slots available to place the safety padlocks of team members.
- Key slot to insert an additional key if other power sources have to be isolated after the maintenance work has started.
- Internal quick-release button to lock/unlock the supplied wall base for both portable and fixed applications.

Reference		 mm.	 kg
SL-106	12	240 x 174 x 40	1



PM/PP-4/6-38-R-Z

SAFETY PADLOCK

Application :

- For locking the separating devices (e.g. circuit breakers) to prevent their operation.
- More secure locking: impossible to drop the key when the shackle is open, the key remains trapped.

Features :

- Available with a keys different (Z).
- Padlock delivered with 2 keys.

Reference	Color		Shackle	
			Ø (mm)	Material
PM-4-38-R-Z	■	Z	4	Metal
PM-6-38-R-Z	■	Z	6	Metal
PP-4-38-R-Z (*)	■	Z	4	Nylon
PP-6-38-R-Z	■	Z	6	Nylon

(*) Unique on the market.



AP-460

PLASTIC WARNING SIGN (SET OF 10 UNITS)

Application :

- Safety Tag-Out badge with warning sign “ELECTRIC SHOCK” and “DO NOT SWITCH ON”.

Features :

- Made of flexible plastic.
- Two-sided printing.
- Supplied by set of 10 badges.

Référence	Ø (mm)	 mm.	
AP-460	1 x 10 mm	120 x 70	0,022



ALPV-L-D

STEERING WHEEL COVER

Application:

- Provides an ideal lock for steering wheel.
- Allows to display a personalized message during the lock-out procedure thanks to the transparent pocket (A5 size).

Features:

- Strap closure at the back with metal eyelets Ø 10 mm for inserting a padlock and self-gripping part.

Reference	Description	g
ALPV-L-D	Locking cover for steering wheel (up to Ø 42 cm)	150
ALPV-XL-D	Locking cover for steering wheel (up to Ø 62 cm)	200



ELECTRICAL PLUG LOCKOUT

Application:

- Suitable for lock-out electrical or pneumatic plugs.
- Prevents the equipment from being inadvertently re-energized.



PL-101

PL-100

Reference	Ø mm		Ø mm	mm.	g
PL-100	2	9	12 mm	85 x 75 x 50	78
PL-101	4	9	25 mm	171 x 102 x 80	222



PL-102

OVERSIZED PLUG AND HOIST CONTROL LOCKOUT

Application:

- In red fabric and black leather.
- Device for blocking remote control of numerical machines, cranes, bridge cranes.
- Locking with padlocks.

Reference		\varnothing mm	mm.	g
PL-102	6	11	460 x 210	65 g



IEC / EN 60900



INSULATING TOOL WITH WEDGE-SHAPED BLADE

Application:

- Insulating tool for LV live working.
- Especially allows to open the plastic covers.

Features:

- Maximum operating voltage: 1 000 V AC - 1 500 V DC.
- Fully insulating.



MO-600

Reference	(mm)	g
MO-600	250	150



TEST AND MEASUREMENT VOLTAGE DETECTORS



MS-917-L

EN 61243-3 (2015) / EN 50110-1
IEC 61010-1 / IEC 61010-031



LOW VOLTAGE DETECTOR DETEX

Application:

- Check the presence of voltage up to 900 V AC, 1 000 V DC according to the model.
- Sound and light continuity for a dead circuit. (threshold of 200 Ohm).
- Unipolar phase identification.
- Search for the polarities of a DC circuit.
- For indoor / outdoor use.

Features:

- Total safety with hazardous voltage indicator light (> 50 V).

Optional accessories:

- Carrying bag with belt loop: M-87285.
- Holder: M-952325.

Reference								
	Hz	Voltage AC	Voltage DC	Threshold Nbr	Category	Rotary field	Lighting	Continuity
MS-917-L	50/60	12 - 690	12 - 750	8	600 V			200 Ω
MS-918-L	50/60	12 - 900	12 - 1 000	8	600 V	•	•	100 Ω



MS-415

NF EN 61 326-1 / NF EN 62311 / NF EN 61243-3



AC AND DC VOLTAGE CONTROLLER

Application:

- Ergonomically optimized voltage controller, ideal for use in tight spaces thanks to its electrode extensions (250 mm and 500 mm).
- It provides a wide detection voltage range: from 50 to 4 200 V DC and from 50 to 3 000 V AC.

Features:

- Maximum nominal voltage: 3 500 V DC, 2 500 V AC.
- Detection voltage: 50 to 4 200 V DC, 50 to 3 000 V AC.

Référence		mm	
MS-415		550 x 160 x 50	0,78



CONTACT PROBES FOR L.V. DETECTORS DETEX MS-917 AND MS-918

Application:

- Contact probes to be used as suspension hooks (MS-8014), round tip contact (MS-8013).
- Light and rigid contact probes for Detex: MS-917 fitted with touch point with elastic cage test.
- Hatch for storage of test probe.

Composition:

- Supplied in soft case.



MS-8013



MS-8014

Reference	↔ (mm)	kg
MS-8013	500	0,29
MS-8014	1 250	0,63

Delivered in a case



Hatch for storage of test probe.



MX-701













DIGITAL MULTIMETER

Application:

- MX-701 Multimeter. Measures DC and AC voltages, AC and DC current, resistance, inductance, temperature. Test of diodes and open circuits (audible alarm).



* Multimeter delivered with connection accessories (2 test leads, 2 temperature probes, 2 crocodile clips), with batteries and cover.

Reference	 AC	 DC					 Class		
MX-701	2 V - 600 V	200 mV - 600 V	40 - 400 Hz	200 μ A to 10 A AC/DC	200 Ω to 20 M Ω	20 nF to 1 000 μ F	III	III - 600 V	0°C to 40°C
		 mm	 kg	Batteries					
	-20 to 1 000°C 0 to +1 800°F	75 x 158 x 35	0,2	3 x 1,5 V AAA LR03	2 probes	LCD 3+1/2 digits			



MX-704

INFRARED THERMOMETER

Application:

- MX-704 High performance infrared thermometer, suitable for detecting abnormal hot spots in electrical installations. Automatic measurement of the target temperature (°C and/or °F) without knowing the emissivity of the material or surface properties.

Reference	mm.	kg	Batteries
MX-704	130 x 180 x 40	0,195	1 battery 9 V 6LR61

* Delivered with battery and a flexible case with a wrist strap



DX-02003

IP2X SAFETY CORDS FOR TEST LEAD POINTS

Application:

- Safety cords for test lead points for measuring devices.

Features :

- Hand guard (for test lead points).
- Compatible with sheathing standard Ø 4 mm connections.
- Retractable sheath. Contact point on elastic cage Ø 4 mm.
- Double-insulated flexible wires 1.20 m length and 1 mm² cross section on Ø 4 mm IP2X elbow end pieces.

Reference	Description
DX-02003	Set of 2 cables BLACK and RED IP2X 4 mm straight male / angled male
DX-02004	Set of 2 cables BLACK and RED IP2X 4 mm male / male with rear female socket



DX-02004



IP2X SAFETY ALLIGATOR CLIPS



DX-02006

Features:

- IP2X safety alligator clips, with hand guard.
- Clamping capacity: Ø 16 mm or 22 mm conductor on flats (M14 nut type).
- Compatible with standard Ø 4 mm plugs.

Composition:

- CX-01222 : alligator clip brown.
- CX-01422 : alligator clip yellow.
- CX-01822 : alligator clip green.
- DX-02006 : 2 alligator clips black and red.

Reference



DX-02006

16 mm for round conductor
22 mm on plate



IP2X SAFETY TEST LEAD POINTS AND CORDS



DX-02002

Application:

- Safety test lead points for measuring devices.

Features :

- Hand guard (for test lead points).
- Compatible with standard Ø 4 mm connections.
- Retractable sheathing. Contact point on elastic cage Ø 4 mm.

Reference



DX-02002

max 20 A

III 600 V

1 000 V AC
1 500 V DC



M-87285



M-87290



M-87292





MO-43

BAGS

Application:

- Bag to carry/store tools, accessories, etc.
- M-87285 : Suitable for the MS-917 voltage detector.

Reference	 mm.	 g
M-87285	260 x 90 x 55	96
M-87290	200 x 120 x 50	120
M-87292	230 x 190 x 70	300
MO-43	280 x 200 x 80	300



KITS KITS

- CATU helps operators to select the right material before working on EHV.
- CATU kits are classified by trade or by operation.

	Trade	Vehicle repair	Expert vehicle repair	MOT or technical control	Road assistance	Going in a training
		KIT-VEH-G-PRO	KIT-VEH-G-EXP	KIT-VEH-TEC	KIT-VEH-DEP	
Delineation	KIT-VEH	*	*			
Lock-Out Tag-Out	KIT-VEH-C	*	*			
Work in the vicinity or under voltage	KIT-VEH-V-TST		*			
Essential set for personal protection	KIT-VEH-PPE	*	*		*	
Comprehensive set for personal protection mandatory for training	KIT-VEH-PPE/02					*
Other		- Signaling damaged vehicle (AT-81)	- Signaling damaged vehicle (AT-81)	- Essential set for personal protection with helmet - Signaling HEV (ACA-10)	- Signaling damaged vehicle (AT-81) - Essentials for Lock-Out Tag-Out (PP-6-38-R-Z & AP-460)	



DELINEATION KIT

Reference	Composition	Quant.	Description
KIT-VEH	AL-323	6	Safety boundary post with ballasted base
	AL-31/25	1	Boundary chain, red and white, length 25 m
	AP-72	2	Warning sign, fitting with AL-323 post



AL-323



AL-31/25



AP-72

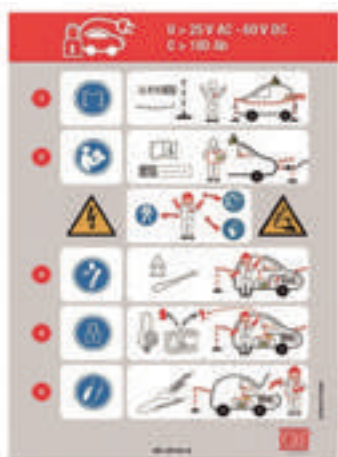

KIT-VEH-C

KIT FOR LOCK-OUT TAG-OUT OPERATIONS

Application :

- Suitable for lock-out tag-out operations on electric and hybrid vehicles and machines.

Reference	Composition	Quant.	Description
	ACA-10	1	Magnetic signal pyramid "Electric Hazard" to work on HEV or batteries
	AP-550-M2V	1	Tag Out plastic sign for HEV with suction cups. 450 x 150 mm
	ATP-551-B	1	Adhesive plastic poster for HEV A4 format
KIT-VEH-C	PP-6-38-R-Z	1	Insulated safety padlock, nylon shackle 38 mm, diameter 6 mm
	AP-460	10	Set of 10 safety Tag-Out badges with warning sign 120 x 70 mm
	MS-917-PG	1	Low Voltage detector DETEX (1 000 V DC)
	MO-600	1	Insulating tool with wedge-shaped blade



KIT-VEH-PPE 02

COMPLETE PPE KIT FOR TRAINING WITH HEAD, BODY, HAND PROTECTION

Application:

- Full kit of PPE for dead and live working on electric and hybrid vehicle battery. Switching jacket included.

Reference	Composition	Quant.	Description
KIT-VEH-PPE/02	MO-286	1	Arc-flash face shield with headband for electrician
	M-87384	1	Face shield - Arc Flash GS-ET-29: class 1 with protective cover
	CG-10-C	1	Insulating gloves, class 0 (1 000 V AC / 1 500 V DC), size 10
	CG-981-10	1	Leather over gloves for the mechanical protection of insulating gloves, size 10
	AFG-2300-2XL	1	Arc flash CAT'ARC jacket, size 2XL
	MO-50	1	Bag



KIT-VEH-PPE

ESSENTIAL PPE KIT

Application :

- Suitable for electric and hybrid vehicles and machines operations.
- Face protection with face shield: protection against short-circuit arcs.
- Protection of the hands with the use of undergloves, insulating gloves and overgloves: electric shocks up to 1000 V AC and mechanical protection.

Reference	Composition	Quant.	Description
	MO-286	1	Face shield - Arc Flash GS-ET-29: class 1
	M-87-384	1	Protective covers for faceshield
KIT-VEH-PPE	CG-0-10-R-28	1	Short insulating gloves (28 cm), IEC 60903 class 0, size 10, 1 000 V AC - 1 500 V DC
	CG-80-H	1	Cotton undergloves for insulating gloves
	CG-981-10	1	Leather overgloves to ensure mechanical protection for insulating gloves, size 10
	CG-36/1	1	Storage pouch for gloves

INSULATED TOOLS KIT INCLUDING A DIGITAL MULTIMETER AND RECUE STICK FOR LIVE WORKING

Application:

- Suitable for electric and hybrid vehicles and machines operating.
- Suitable for work in the vicinity or under voltage (maximum operating voltage 1 000 V AC – 1 500 V DC).



KIT-VEH-V-TST

KIT-VEH-V-TST

Reference	Composition	Quant.	Description
	MP-220	1	Insulating orange blanket class 0, 1x1 m
	MP-627-D	3	Small model clamp for blanket
	MP-635/15-D	4	Insulating cap class 0, Ø 15 mm
	MP-635/30-D	4	Insulating cap class 0, Ø 30 mm
	MP-635/60-D	2	Insulating cap class 0, Ø 60 mm
	MP-19/1	1	Wide red electrical adhesive insulating tape 50 m x 50 mm
	MP-29/3-S	1	Insulating bag
	AT-67/1	20	Warning sticker "BATTERY HAZARD" 100 mm
	MX-701	1	Digital multimeter
	CS-45/2	1	Rescue stick with insulated permanent hook 45 kV - 1,65 m
	MO69308/HAT-D	1	Set of sockets 3/8"
	MO-66000C	1	Insulating universal pliers
	MO-710-D	1	Insulated brush
	MO-755-D	1	Insulated mirror
	KIT-23	1	5 bi-material screwdrivers kit
	MO-69213	1	Insulated ratchet wrench
	MO-7582-D	1	Magnet on flexible handle
	MO-67501	1	Insulated cable cutter
	MO-69051	1	Insulated torque wrench 3/8" 4-20 Nm

HEAD AND HAND PROTECTION KIT FOR SAFE INSPECTIONS

Application:

- Suitable for electric and hybrid vehicles and machines.
- Hand protection with insulating gloves, head protection with insulated helmet. Easy to store in the CATU bag.



KIT-VEHC-TEC

Reference	Composition	Quant.	Description
	MO-185-BL	1	Insulated helmet with retractable screen
	M-87-384	1	Protective covers for helmets and visors. 440 x opening Ø 435 mm
	CG-0-10-R-28	1	Short insulating gloves (28 cm), class 0, size 10, 1 000 V AC - 1 500 V DC
KIT-VEHC-TEC	CG-80-H	1	Cotton undergloves for insulating gloves
	CG-981-10	1	Leather overgloves to ensure mechanical protection for insulating gloves, size 10
	CG-36-1	1	Storage case for insulating gloves
	ACA-10	1	Signal pyramid (3 sides) with magnetic base
	MO-42/2	1	Bag to carry/store tools, accessories, etc.

HEAD AND HAND PROTECTION KIT INCLUDING SIGNALING

Application:

- Suitable for electric and hybrid vehicles and machines.
- Hand protection with the insulating gloves.
- Head protection with an Arc-Flash face shield.
- Universal signaling and insulated padlock.
- Easy to store in a CATU bag.



KIT-VEH-DEP

Reference	Composition	Quant.	Description
KIT-VEH-PPE	MO-286	1	Faceshield - Arc Flash GS-ET-29: class 1
	M-87-384	1	Protective covers for helmets faceshield
	CG-0-10-R-28	1	Short insulating gloves (28 cm), IEC 60903, class 0, 1 000 V AC - 1 500 V DC
	CG-80-H	1	Cotton undergloves for insulating gloves
	CG-981-10 x	1	Leather overgloves to ensure mechanical protection for insulating gloves, size 10
	CG-36-1	1	Storage case for insulating gloves
KIT-VEH-DEP	AT-81	1	Set of 40 temporary stickers "Damaged vehicle"
	PP-6-38-R-Z	1	Insulated safety padlock, nylon shackle, Ø 6 mm
	AP-460	1	Set of 10 safety Tag-Out badges
	MO-42/2	1	Bag to carry/store tools, accessories, etc.

HEV VEHICLE REPAIR KIT

Application :

- Protective equipments against electrical risk.
- Suitable for operator working on electric and hybrid vehicles.
- For delineation, Lock-Out, and signaling.



KIT-VEH-GPRO

Reference	Comp.	Quant.	Description
KIT-VEH	AL-323	6	Balasted boundary posts red and white
	AL-31/25	1	Plastic chain with red and white links 25 m
	AP-72	2	Plastic signs. Dimensions 450 x 150 mm.
KIT-VEH-PPE	MO-286	1	Face shield - Arc Flash GS-ET-29: APC1
	M-87-384	1	Protective bag for face shield.
	CG-0-10-R-28	1	Pair of short insulating gloves (28 cm), class 0 (1 000 V AC / 1 500 V DC), size 10
	CG-80-H	1	Pair of cotton under-gloves
	CG-981-10	1	Pair of leather overgloves for the mechanical protection of insulating gloves, size 10, protection against thermal risks (EN 407)
KIT-VEH-GPRO	CG-36-1	1	Glove storage bag
	AT-81	1	Set of 40 "DAMAGED VEHICLE" stickers.
KIT-VEH-C	ACA-10	1	3-sided magnetic warning pyramid
	AP-550-M2V	1	Warning sign with suction cups
	ATP-551-B	1	Adhesive plastic poster: Golden Rules
	PP-6-38-R-Z	1	Safety padlock with insulating shackle Ø 6 mm
	AP-460	10	Safety Tag-Out badges
	MS-917-PG	1	LED voltage detector 1 000 V DC
	MO-600	1	Insulating wedge tool suitable for maintenance operations on electric vehicle batteries, especially for disconnection.

HEV VEHICLE REPAIR KIT

Application :

- Protective equipment against electrical risk.
- Suitable for operator working on electric and hybrid vehicles.
- For delineation, Lock-Out signaling, and working in the vicinity of voltage or working live.



KIT-VEH-GEXP

Reference	Comp.	Quant.	Description
KIT-VEH	AL-323	6	Balasted boundary posts red and white
	AL-31/25	1	Plastic chain with red and white links 25 m
	AP-72	2	Plastic signs. Dimensions 450 x 150 mm.
KIT-VEH-PPE	MO-286	1	Face shield - Arc Flash GS-ET-29: APC 1
	M-87-384	1	Protective bag for face shield.
	CG-0-10-R-28	1	Pair of short insulating gloves (28 cm), class 0 (1 000 V AC / 1 500 V DC), size 10
	CG-80-H	1	Pair of cotton under-gloves
	CG-981-10	1	Pair of leather overgloves for the mechanical protection of insulating gloves, size 10, protection against thermal risks (EN 407)
KIT-VEH-GEXP	CG-36-1	1	Glove storage bag
	AT-81	1	Set of 40 "DAMAGED VEHICLE" stickers.
KIT-VEH-C	ACA-10	1	3-sided magnetic warning pyramid
	AP-550-M2V	1	Warning sign with suction cups
	ATP-551-B	1	Adhesive plastic poster: Golden Rules
	PP-6-38-R-Z	1	Safety padlock with insulating shackle Ø 6 mm
	AP-460	10	Safety Tag-Out badges
	MS-917-PG	1	LED voltage detector 1 000 V DC
	MO-600	1	Insulating wedge tool suitable for maintenance operations on electric vehicle batteries, especially for disconnection.

CONTINUED ON NEXT PAGE



CONTINUED FROM PREVIOUS PAGE



KIT-VEH-GEXP

KIT-VEH-V-TST

Reference	Comp.	Quant.	Description
	MP-220	1	Insulating flexible mat IEC 61112 Class 0; dimensions: 1 x 1 m
	MP-627-D	3	Insulating clamps for fastening elastomer or plastic insulating or protective blankets. Length: 80 mm
	MP-635/15-D	4	Insulating cap Ø: 15 X 100 mm
	MP-635/30-D	4	Insulating cap Ø: 30 X 120 mm
	MP-635/60-D	2	Insulating cap Ø: 60 x 140 mm
	MP-19/1	1	Red insulating adhesive tape. Dimension: 50 m x 50 mm
	MP-29/3-S	1	Insulating cover. Dimension: 305 x 225 mm
	AT-67/1	20	Self-adhesive warning sign «WARNING ! BATTERY CHARGING». Side of 10 cm
	MX-701	1	CAT III 600 V multimeter with LCD digital display for measuring AC and DC voltages, AC and DC currents as well as resistances, capacitances and temperature
	CS-45/2	1	Rescue stick 45 kV 1.65 m with insulated hook
	MO69308/HAT-D	1	Socket set 3/8" with ratchet and extension bar (140 mm) in case. Female hex sockets: 8-10-12-13-14-17-19-21-22-23; male hex sockets: 3-4-5-6-8; Torx sockets: TX15-TX20-TX30-TX40-TX50
	MO-710-D	1	Insulating brush
	MO-755-D	1	Insulating mirror
	KIT-23	1	Insulated screwdriver set for live working. Flat-blade screwdriver: 4-6-8 mm; Pozidriv screwdriver: PZ1, PZ2. IEC 60900
	MO-72142	1	Bent snipe nose plier 160 mm. IEC 60900
	MO-7582-D	1	Magnet insulated gripping tool mounted on flexible shaft
	MO-67501	1	Insulated cable cutter 170 mm. IEC 60900
	MO-69051	1	3/8" insulated reversible torque wrench. Torque: 4 to 20 N.m. IEC 60900

After Sales Services

- xavier.lebec@catuelec.com
- Phone: +33 (0)1 42 31 46 85
- latif.ozmen@catuelec.com
- Phone: +33 (0)1 42 31 46 86

Technical Assistance

- corinne.peigne@catuelec.com
- Phone: +33 (0)1 42 31 46 24
- charles.saulnier@catuelec.com
- Phone: +33 (0)1 42 31 63 10

The characteristics and technical informations stated in our literature are only for your guidance and therefore cannot be considered as contractual. our company is entitled to modify at any time the characteristics of its equipment.

In case of modification of these characteristics, our company would not be obliged to supply materials conform to those previously in force.



© 2021 CATU SAS BAGNEUX

All reproduction, adaptation and translation rights reserved for all countries.

DISCOVER OUR MAIN PUBLICATIONS

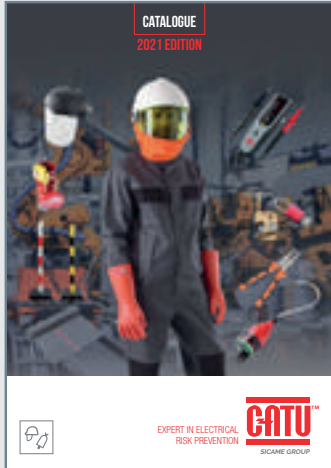

General catalogue



Railways catalogue



Forklift solutions flyer



Electrical insulating brochure

Distributed by:

©Nataliya Hora - 123rf.com
 PEFC 10-31-2036 / Certified PEFC / This product comes from sustainably managed forests and controlled sources. / pefc-france.org