



THORNE &
DERRICK
INTERNATIONAL

Thorne & Derrick
+44 (0) 191 410 4292
www.powerandcables.com

PFISTERER



2DIREKT

Safe and simple cable connection
for transformers and busbars

2DIREKT

Simple, safe, versatile

In modern substation engineering, cable connections are increasingly implemented using screw technology. The 2DIREKT terminal clamp by PFISTERER is a solution for connections to transformers and busbars. 2DIREKT combines simple installation with a compact, cost-effective design.

Connects directly to transformer bushing or busbar

The 2DIREKT clamp is connected directly to the distribution transformer. It screws onto the transformer bushing and is secured via a clamping groove and clamping screw. This reduces the amount of installation work and the risk of connection errors. No cable lugs have to be pressed on, and no wire-end ferrules have to be fitted. There are fewer points of contact and transition resistance is minimised.

The 2DIREKT A version allows cables to be connected directly to busbars. Fine grooves on the underside of the clamp enables connection without additional components directly on the busbar.

Safety during installation and operation

The patented conductor connection system eliminates damage to the conductor during installation. A rotating plate on the base of the clamping bolt prevents individual fine-wire conductors from being damaged or even cut off. During operation, the plate functions like a spring and ensures constant contact pressure.

One clamp for all cross-sections

The 2DIREKT clamp can be used for multiple cross-sections. Various versions are available for cross-sections of 16-95 mm², 35-240 mm² and 185-400 mm². All forms of class 1, 2 and 5 copper conductors as well as class 1 and 2 aluminium conductors can be connected.

This makes the 2DIREKT not only practical but also cost-effective. The right clamp is always available on site, and stockkeeping is much simpler.

2DIREKT clamps are electrically type-tested in accordance with IEC 61238-1 class A.

Compact, sophisticated design

2DIREKT offers two cable outlet directions in one body. The clamping channel and the threaded hole for the clamping screw are identical, so the conductor can be connected at a 90° angle if required. This ensures easy installation even in confined environments.

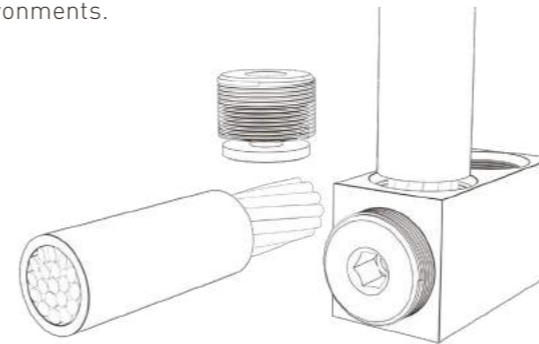

The 2DIREKT is connected directly to the distribution transformer, making palm terminals, cable lugs, sleeves and nuts redundant.

Benefits

- Conductors can be connected vertically and/or horizontally
- Connection without wire-end ferrule or cable lug
- Individual strands are not damaged
- Reduced space requirements
- Removable connection
- Installation with standard tools, no compression required
- Range-taking: fewer different types means simpler stockkeeping

2DIREKT facts

- Voltage: up to 1 kV
- Current: up to 4 kA
- Conductor cross-section: 16 to 400 mm²
- Conductor: aluminium class 1 and 2, copper class 1, 2 and 5 (fine wire)
- Transformerclamp for bushings per DIN EN 50386





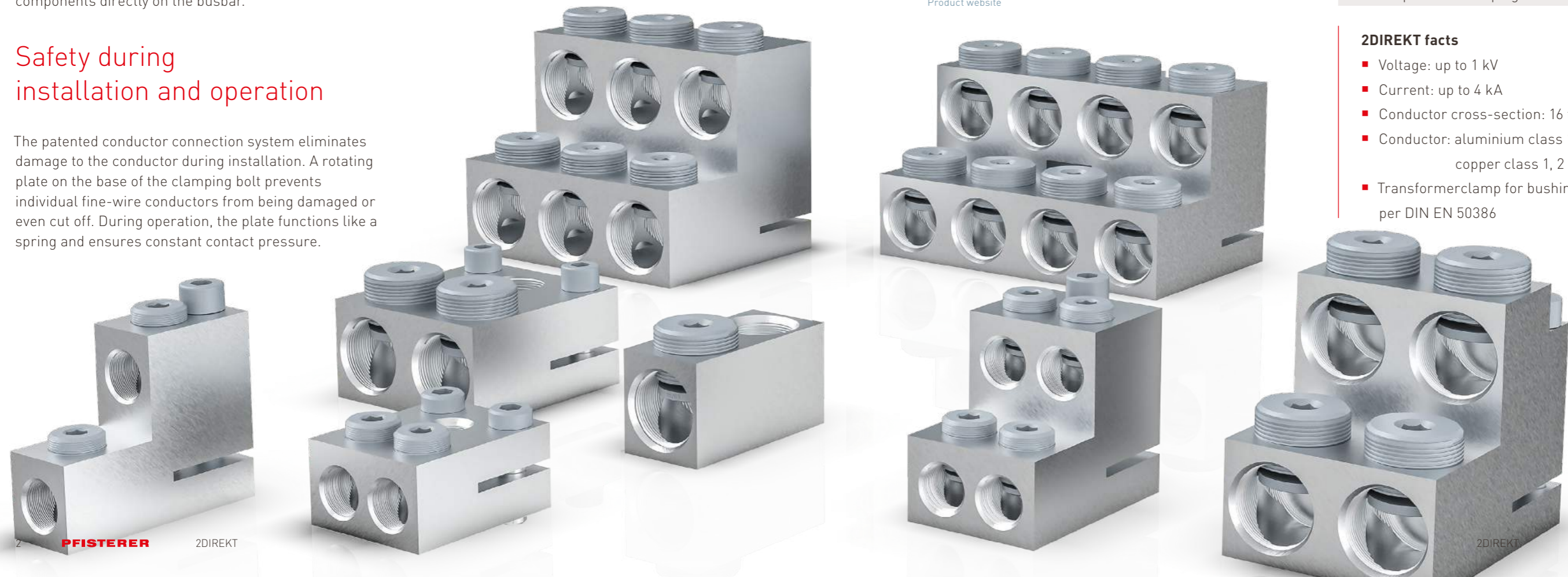









Product website









2DIREKT

Conductor cross-section [mm²]*	Bolt connection d [mm]	Dimensions			Suitable covers		Article no.	
		l [mm]	w [mm]	h [mm]	Indoor use	Indoor & outdoor use		
2DIREKT S								
Two-conductor clamp								
	16 - 95	M8	44	54	26	-	331 756 023	
	16 - 95	M12	44	54	26	-	331 756 020	
	16 - 95	M20	44	54	26	-	331 756 022	
Two-conductor clamp								
	16 - 95	M8	24	68	57	-	331 756 004	
	16 - 95	M12	24	68	57	-	331 756 001	
	16 - 95	M16	24	68	57	-	331 756 002	
	16 - 95	M20	24	68	57	-	331 756 003	
Four-conductor clamp								
	16 - 95	M12	44	68	57	-	331 756 010	
	16 - 95	M16	44	68	57	-	331 756 011	
	16 - 95	M20	44	68	57	-	331 756 012	
2DIREKT								
Single-conductor clamp								
	35 - 240	M12	64	30	34	331 345 001	331 345 002	331 745 001
	35 - 240	M16	64	30	34	331 345 001	331 345 002	331 745 003
	35 - 240	M20	64	30	34	331 345 001	331 345 002	331 745 002
	35 - 240	M12	64	30	34	331 345 001	331 345 002	331 745 012
	35 - 240	M16	64	30	34	331 345 001	331 345 002	331 745 011
	35 - 240	M20	64	30	34	331 345 001	331 345 002	331 745 010
Two-conductor clamp								
	35 - 240	M12	70	64	34	331 346 003	331 346 004	331 746 004
	35 - 240	M16	70	64	34	331 346 001	331 346 002	331 746 006
	35 - 240	M20	70	64	34	331 346 001	331 346 002	331 746 003
	35 - 240	M20 x 1.5	70	64	34	331 346 001	331 346 002	331 746 007
	35 - 240	M30 x 2	70	64	34	331 346 001	331 346 002	331 746 002
	35 - 240	M42 x 3	84	64	34	331 347 001	331 347 002	331 746 008
	35 - 240	M48 x 3	84	64	34	331 347 001	331 347 002	331 746 005
	35 - 240	M30 x 2	84	36	74	-	-	331 748 201
	35 - 240	M12	84	36	74	-	-	331 748 203
	35 - 240	M20	84	36	74	-	-	331 748 204
Four-conductor clamp								
	35 - 240	M12	84	64	74	331 347 003	331 347 004	331 747 005
	35 - 240	M20	84	64	74	331 347 001	331 347 002	331 747 004
	35 - 240	M27 x 1.5	84	64	74	331 347 001	331 347 002	331 747 006
	35 - 240	M30 x 2	84	64	74	331 347 001	331 347 002	331 747 001
	35 - 240	M33 x 3	84	64	74	331 347 001	331 347 002	331 747 007
	35 - 240	M42 x 3	84	64	74	331 347 001	331 347 002	331 747 002
	35 - 240	M48 x 3	84	64	74	-	-	331 747 003
Six-conductor clamp								
	35 - 240	M30 x 2	84	100	74	-	-	331 749 010
	35 - 240	M42 x 3	84	100	74	-	-	331 749 011
	35 - 240	M48 x 3	84	100	74	-	-	331 749 012
Eight-conductor clamp								
	35 - 240	M42 x 3	84	132	74	331 348 002 + 614 556 002	331 348 002 + 614 556 002	331 754 001
	35 - 240	M48 x 3	84	132	74	331 348 002 + 614 556 002	331 348 002 + 614 556 002	331 754 002
2DIREKT XL								
Two-conductor clamp								
	185 - 400	M42 x 3	118	89	53	-	-	331 752 202
Four-conductor clamp								
	185 - 400	M30 x 2	118	89	112	331 348 002 + 614 556 003	331 348 002 + 614 556 003	331 752 001
	185 - 400	M42 x 3	118	89	112	331 348 002 + 614 556 003	331 348 002 + 614 556 003	331 752 002
	185 - 400	M48 x 3	118	89	112	331 348 002 + 614 556 003	331 348 002 + 614 556 003	331 752 003
Six-conductor clamp								
	185 - 400	M42 x 3	118	127	112	331 348 002	331 348 002	331 753 001
	185 - 400	M48 x 3	118	127	112	331 348 002	331 348 002	331 753 002
	185 - 400	M55 x 3	118	127	112	-	-	331 753 003

*Aluminium conductors class 1 and 2, copper conductors class 1, 2 and 5 (fine wire)

Fixed ball points

	Fixed ball point diameter [mm]	Max. short-circuit current I _s [kA]	Article no.
Fixed ball point with pressure screw for 2DIREKT			
	20	23.7	331 750 100
	25	29.6	331 750 101
	20	23.7	331 750 102
Fixed ball point for 2DIREKT XL			
	25	29.6	332 750 202

PFISTERER offers fixed ball points for 2DIREKT and 2DIREKT XL suitable for connecting earthing and short-circuiting devices. Fixed ball points with pressure screw can be used both in a free conductor channel on the 2DIREKT and to secure a conductor. Fixed ball points without pressure screw can only be used in free clamping channels.

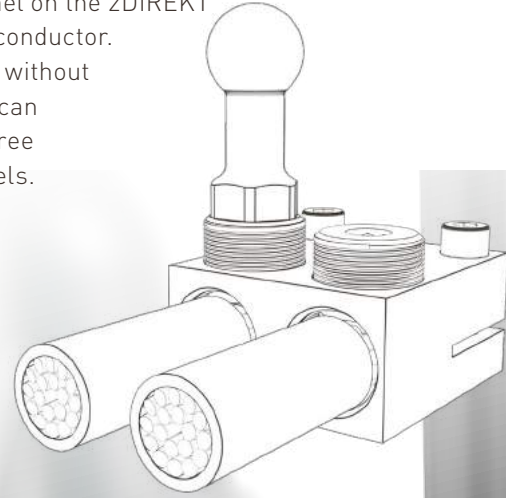

Covers with testing option

Specially designed covers ensure comprehensive personal safety and operational reliability. They are available for indoor and outdoor applications. They make the connection touch-safe, keep out dirt, and protect the connection from weathering. All versions meet the requirements of protection class IP2X. The cover for indoor use has a flip-back top for connecting earthing and short-circuiting devices.

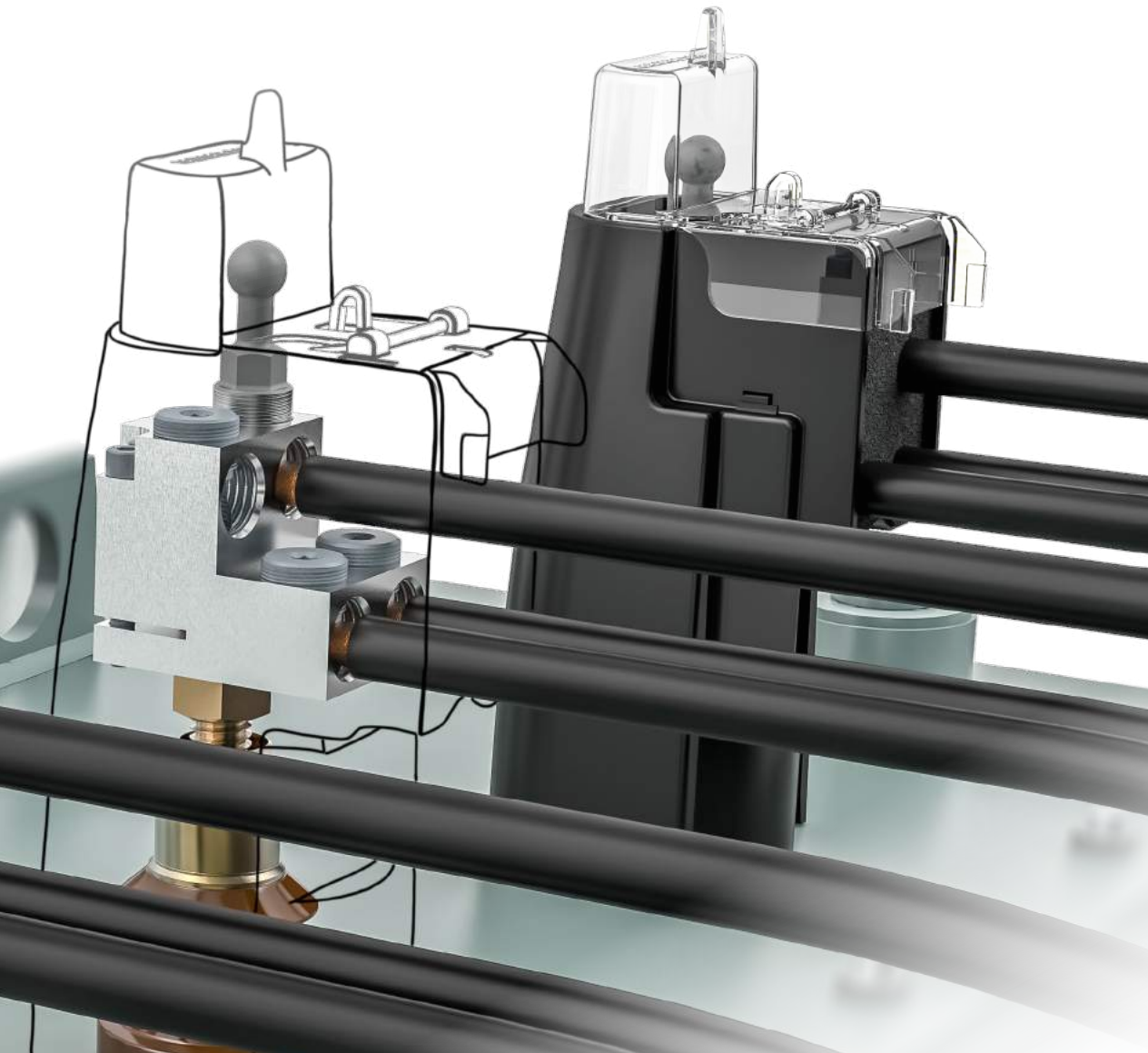

Clamping screw

Clamping groove

Rotating friction disc

Double thread / contact grooves

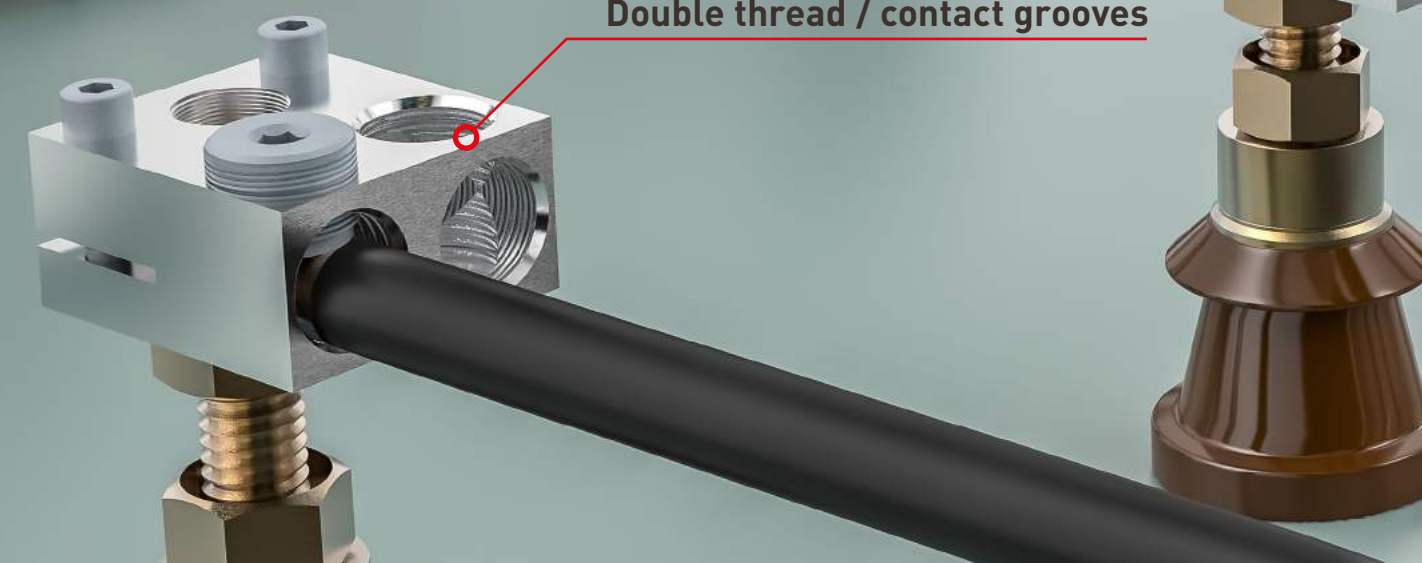





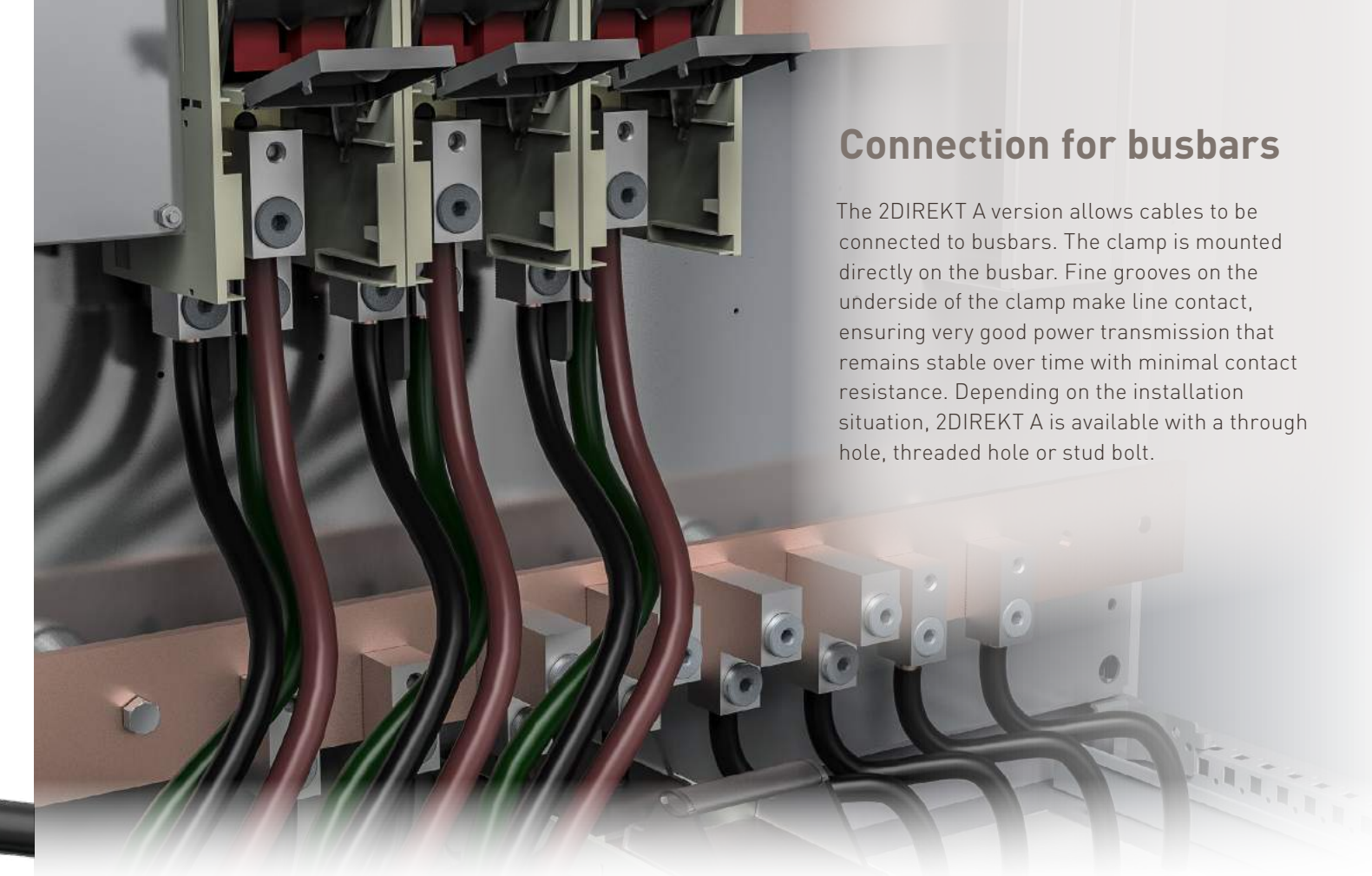

Connection for busbars

The 2DIREKT A version allows cables to be connected to busbars. The clamp is mounted directly on the busbar. Fine grooves on the underside of the clamp make line contact, ensuring very good power transmission that remains stable over time with minimal contact resistance. Depending on the installation situation, 2DIREKT A is available with a through hole, threaded hole or stud bolt.



2DIREKT A

Conductor cross-section [mm²]*	Conductor channel bore [mm]	Connection		Dimensions			Assembly		Article no.	
		Type	Size d	l [mm]	w [mm]	h [mm]	Tool	Tightening torque [Nm]		
2DIREKT A S										
Two-conductor clamp										
	16 - 95	Ø 14.4	Thread	M10	54	44	26	SW6	25	331 757 104
	16 - 95	Ø 14.4	Thread	3/8" - 16 UNC	54	44	26	SW6	25	331 757 105
	16 - 95	Ø 14.4	Thread	1/2" - 13 UNC	54	44	26	SW6	25	331 757 106
Two-conductor clamp (L-shaped)										
	16 - 95	Ø 14.4	Thread	M12	68	24	57	SW6	25	331 757 001
	16 - 95	Ø 14.4	Thread	3/8" - 16 UNC	68	24	57	SW6	25	331 757 006
	16 - 95	Ø 14.4	Thread	1/2" - 13 UNC	68	24	57	SW6	25	331 757 007
2DIREKT A										
Single-conductor clamp										
	35 - 240	Ø 24.4	Drilling	Ø11 mm	64	30	34	SW8	55	331 745 004
	35 - 240	Ø 24.4	Drilling	Ø13.5 mm	64	30	34	SW8	55	331 745 005
	35 - 240	Ø 24.4	Drilling	M10	64	30	34	SW8	55	331 745 006
Two-conductor clamp										
	35 - 240	Ø 24.4	Drilling Thread	Ø17.5 mm / 2*M10	70	64	34	SW8	55	331 748 002
Two-conductor clamp (L-shaped)										
	35 - 240	Ø 24.4	Thread	M16	84	30	74	SW8	55	331 748 100
	35 - 240	Ø 24.4	Stud	M16	84	30	74	SW8	55	331 748 101
	35 - 240	Ø 24.4	Thread	M12	84	30	74	SW8	55	331 748 102
	35 - 240	Ø 24.4	Stud	M12	84	30	74	SW8	55	331 748 103
2DIREKT A XL										
Two-conductor clamp (L-shaped)										
	185 - 400	Ø 33.4	Thread	M16	118	44	112	SW8	80	331 752 210

*Aluminium conductors class 1 and 2, copper conductors class 1, 2 and 5 (fine wire)

The PFISTERER Group is amongst the world's leading specialist equipment and system suppliers in the energy infrastructure industry. Around 2,100 employees develop, produce and distribute components and complete solutions for the particularly sensitive interfaces in modern energy networks. With a complete range of products and services, the PFISTERER Group provides customised solutions for the complete transmission chain from low and medium to high and ultra-high voltage. Everything from a single source. Worldwide.