



  
LOVINK  
ENERTECH

We connect your power



We are Lovink Enertech. We want to work with you to help create an efficient and safe society. Our part involves supplying reliable and innovative solutions for constructing, improving and maintaining your electricity systems.

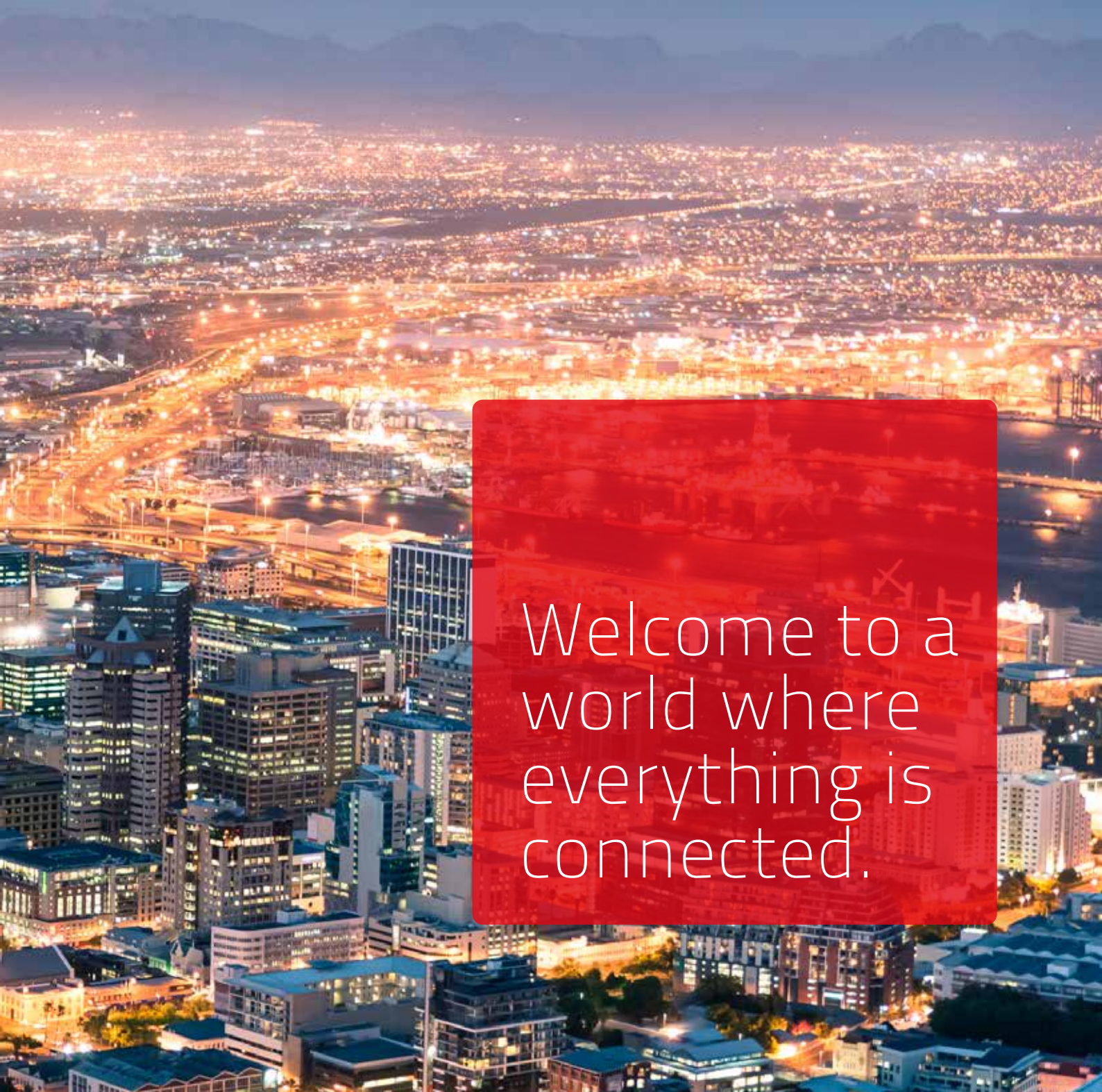

Welcome to a world where everything is connected.

We develop, produce and supply innovative and reliable cable accessories to grid operators, industrial companies, contractors and engineering firms. Besides that, our desire is to offer you additional support with specialized advice and guidance. So we are both contributing to a world which is continuously on the move.

Our accessories score particularly well when it comes to 'failure-free operation.' Thanks to an extremely low failure rate, our LoviSil® product group heads the international

ranking for best category performance. We are also able to present similar scores for our other product groups.

Due to their smart, intuitive design and universal technology for all voltage levels, our cable accessories are easy to install. This helps to save time and keep the risk of errors to a minimum. Together with a minimum service life of 40 years, high mechanical strength and exceptional resistance to environmental factors, this adds up to a very attractive Total Cost of Ownership (TCO).



The best connections are made together.

The best results are obtained together. Your situation, preferences and objectives form a foundation for the solutions and support we offer. We supply high quality standard accessories wherever possible; we provide tailor-made solutions wherever necessary or preferred.



As a supplier of cable accessories, we can offer a comprehensive range of products from 1 to 36 kV. And there's more. We can help to optimize your ordering and administration processes and we offer storage, management and distribution solutions to give you trouble free logistics. Customer specific solutions, JIT and last minute deliveries: we will quickly respond to your needs.

Specially trained people at Lovink Enertech make sure your staff is able to effectively install our products. Familiarization courses are designed to enable jointers, qualified at the relevant voltages,

to understand the practical and theoretical aspects of Lovink technology. Besides, our special support engineers can offer jointers assistance in the field.

The Lovink Enertech brand is synonymous with intelligent, innovative and cost-effective solutions for the worldwide energy sector, the industrial sector and the sustainable energy market. We are continuously developing, supporting and implementing new ideas. These solutions continue to connect us to your dynamic assets.

**We connect your power!**



The electricity market is developing extremely quickly. The ecological impact of our infrastructure has been placed in the spotlight and terms like smart grids, energy transition and green nets have become part of everyday vernacular. Technological innovation is the answer to these developments, and this is an area where Lovink Enertech fulfils an important role.



# Tomorrow's energy supply.

Changes in the grid, such as the introduction of sustainable energy production, are placing a greater burden on cable networks. As a result, cable joints must be able to resist these changing influences.

Cable joints are important links within cable networks. LoviSil®, the liquid silicone-based technology we have developed, is able to offer a reliable solution to these challenges.

Our development strategy focuses on reliability, sustainability and ease of assembly. We are using the latest technologies, and a team of smart engineers, to create products of the future.

This is Lovink Enertech's way of helping to realize reliable electricity grids, which help to ensure a stable economy and protect our environment.



# Content

## 1. LoviSil®

Cable joints for  
paper-insulated and  
polymeric cables

6/10 (12) kV – 18/30 (36) kV

## 2. LoviFlex®

GSE terminations  
for polymeric cables

6/10 (12) kV

## 3. Accessories

Protolin® resin  
Tools  
Clamps and roll springs  
Wrapping tapes

11-22    23-25    27-31



Transition joints Airport



Straight through joints high water table



Branch joints

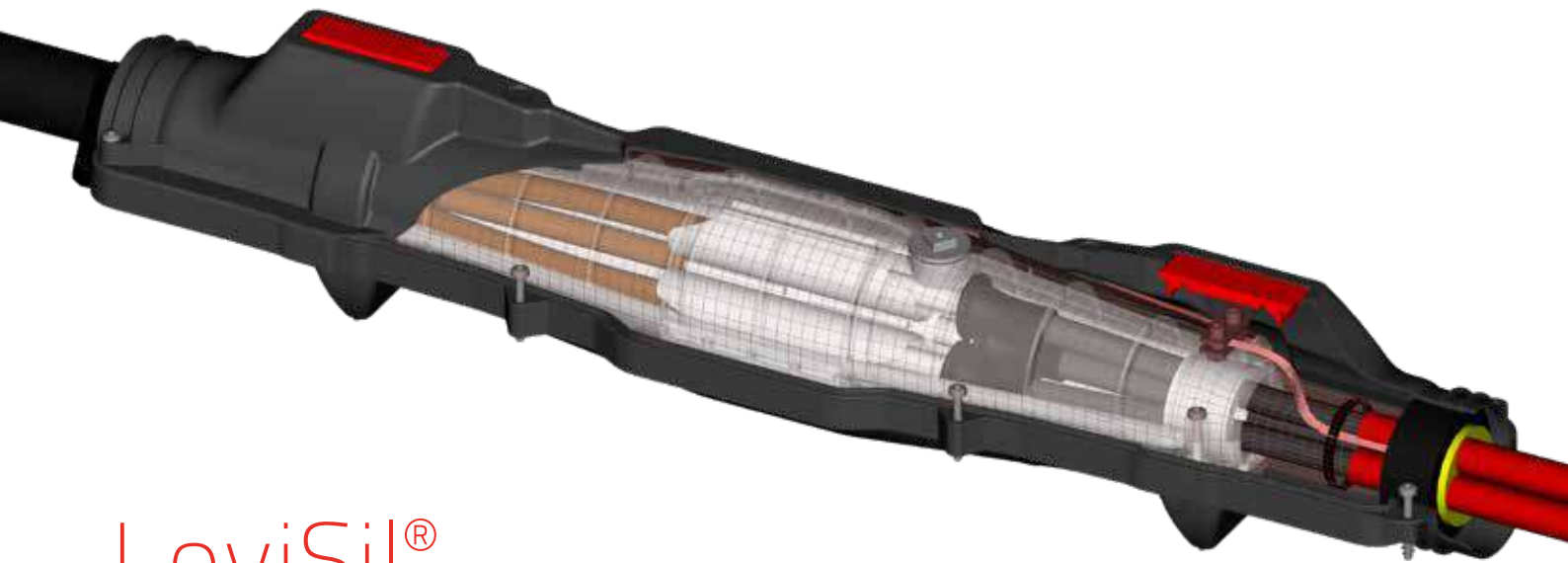

# LoviSil<sup>®</sup> medium voltage joints 12-36 kV



Oil refill joints in switch gear station



Feed-in joints Solar park



Cross-bonding joints



LoviSil®  
medium voltage  
joints  
12-36 kV

LoviSil® medium voltage cable joints have been developed featuring fluid silicones that can boast 30 years proven field experience with an extremely low failure rate. Thanks to the construction and characteristics of the silicone based insulation material, LoviSil® joints offer a reliable connection with polymeric and especially paper-insulated cables.

#### Applications

LoviSil® cable joints are available as transition, straight through and branch joints. In addition Lovink EnerTech has also applied LoviSil® technology for cross-bonding joints, oil refill joints, feed-in joints and repair joints.

#### Electrical insulation

The principle dielectric is contained within an ABS inner shell, utilizing a combination of polymeric spacers (12-24 kV) or silicone sleeves (36 kV) and a high-grade silicone-based compound. This compound remains fluid, thus minimizing the risk of discharge e.g. from dried out papers.

#### Mechanical protection

Mechanical protection is provided by a strong ABS outer shell, filled with two-component polyurethane resin. This resin provides long-term moisture resistance. A copper wire mesh serves as the electrical screen.

#### Earth and screen protection

The polyurethane resin also provides a tough environmental protection for the main earth bond and screen components. With its searching characteristics, it encapsulates every item thus providing excellent corrosion resistance.

#### Sealing

Exceptional bonding of polyurethane resin to ABS provides a guaranteed seal to the outer shell. Should any moisture penetrate through to the inner joint, a soft, water resistant and insulating rubber is formed around the cores. This cured LoviSil® provides an additional layer of protection against the effects of moisture ingress.

#### Equivalent $\epsilon_r$ value

The dielectric constant ( $\epsilon_r$  value) of liquid silicone is practically identical to the insulation of polymeric cables (XLPE/ EPR) and remains so even when cured. This provides a consistently homogeneous electric field.

#### Universal:

from one basic concept all cables can be connected

#### Reliability & Quality:

fluid silicone technology

#### Cost savings:

extremely low failure rate

## Protection of cables

When applied to paper-insulated cables, the silicone compound performs the same insulating function as cable grease. This guarantees the long-term quality of connection.

## Tests

LoviSil® cable joints have been tested in accordance with HD 628 / EN IEC 61442 and HD 629 (CENELEC). The tests were executed under water pressure of 2 bar. LoviSil® joints are extremely suited to applications in areas of waterlogged soils and high water tables.

## Installation

The installation accomplished in 7 steps:

1. Cable preparation
2. Fitting of field control and connectors
3. Fitting of inner joint
4. Filling inner joint LoviSil®
5. Fitting earth and screen
6. Assembly of outer joint
7. Filling outer joint with Protolin®

LoviSil® joints are distinctive for their ease of installation. Installation steps are intuitive, parts are user-friendly by design and pre-installed wherever possible.

During the filling process, levels can be controlled effectively. The transparent inner joint and red outer joint are provided with level indicators. The bag of LoviSil® features handles and a filling spout.

## Example installation instruction

### 1 Preparation of the cables

**PILC**

Slide the cable seal on the cable before cutting and removing the lead sheath. Use Lovink silicon paste as a lubricant.

These measurements are also to be used for single-core or 3 single-core cables.

M75: 450 mm  
M85: 490 mm  
M105: 635 mm

Polymeric outer sheath: 420 mm 460 mm 605 mm

**XLPE-TS S(A)W 3-core**

Strip the cable to the required dimensions, then slide the cable seal into position using the Lovink silicon paste as lubricant.

These measurements are also to be used for single-core or 3 single-core cables.

M75: 420 mm  
M85: 460 mm  
M105: 605 mm

### Dimensions connectors

**With blocked connectors:**  
1/2 connector + 5 mm

**Without blocked connectors:**  
1/2 connector + 10 mm

Always abrade polymeric outer sheath (70mm) and/or lead sheath (190mm)!

If necessary, make a crossing first before cutting the cables!

**PILC**

De-burr any sharp conductor/sheath edges and mask with PVC tape to prevent damage when applying the cable seal.

**XLPE**

Bend back the screen wires but do not cut them!

### 2 Fitting of field control and connectors

Stress control not on all 12kV PILC

1. Position the stress cones with the push-on-applicator and Lovink silicon paste.
2. In the case of EPR cable, apply void filling tape over the interface between EPR and semi-conductive layer.
3. Slide the stress cones 10mm over the end of the semi-conductive layer.
4. First clean the core insulation and then the stress cones with a clean Lovink wet cleaning tissue.
5. Fit the connectors according to the specifications of the supplier.

### 3 Fitting of inner joint

Before positioning the tube set, clean the connection with a clean Lovink wet cleaning tissue.

Clean all surplus silicon paste from cable surfaces.

1. Click the tubes into each other and centralize over the connectors.
2. For 3 x single core cables - place a plastic cable tie around the cables sheaths.
3. Use the inner shell to gauge and reposition the cable seals. Offer up the outer shell to determine the position of the foam filler pieces (Only for 3 x single core cables). Place the Foam filler pieces.
4. Fit the upper shell to the lower shell.

5. Apply Lovink silicon paste on the outer contour of the cable seals.
6. Click the upper shell partly on the lower shell.
7. Turn all screws with a 6mm allen key according to the image above (8-12Nm). Attention! The M105 joint has 8 screws.
8. Check if the shells are fully locked and snapped shut.

### 4 Filling the inner joint with LoviSil®

1. Position the LoviSil® bag on the fill opening as indicated in the instruction on the bag.
2. Hold the spout firmly on the fill opening.
3. Fill the inner joint with LoviSil® to the level between MIN and MAX.
4. Tighten the plug with a 19 mm spanner.

### 5 Fitting the earth

**A. Lead cover + armour**

1. If required, wind 3 layers of gauze over the armour (wires or tape). Fix the smaller braid to the armour with a jubilee clip.
2. Fit the small and big braid to the lead sheath with a constant force spring or LDV-clamp.

**B. Lead covered cable**

3. Fix the LDV-clamp / spring 40mm from the armour over the braid.
4. Tighten the bolt until the clearances between the disc springs are closed and turn the bolt 360° back.

**C. Earthstrip**

5. Fix the braid to the earth strip with a 6mm allen key (10 Nm) and cut away the excess braid.

**Installation:**  
easy, intuitive  
and fast

**Proven technology:**  
more than 30 years  
field experience

The installation instructions are logical and clear. Simple images, some supported with text, guide the jointer step by step through installation to a satisfactory conclusion.

Example base module  
12-24 kV



**Modular system**

LoviSil® joints are ordered using a modular system providing solutions for all cable combinations.

**Base module** : This module contains all the “hardware” for the joint. Selection of the base module is dependent on cable sizes.

**Resin module** : This module contains all filling compounds for the joint, including the LoviSil® liquid.

**Cable module** : This module contains items for application on the cables to be connected.

Example resin module



Bespoke cable modules for unique applications are available.

*The modular system offers logistic benefits, because it is not necessary to keep separate joints in stock for each cable combination. From one basic concept, all cable types can be connected.*

# Product overview LoviSil® M Transition and straight through joints

The transition and straight through joints of Lovink Enertech are universal and can be used on paper-insulated (PILC or PICAS) and polymeric (XLPE or EPR) cables regardless of cable type: 1 and 3-core, large and small cross-sections and different armours. Bespoke cable modules are available to cater for uncommon cable types.

Voltage	Type	Cable	Conductor size (mm <sup>2</sup> )*	Diameter conductor crossed conductors (mm <sup>2</sup> )	Max. cross section for crossed cores (mm)	
12 kV	M75	Polymeric/paper (1 core)	95 - 630	N/A.	72	
		Polymeric/paper (3 x 1 core)	35 - 150	N/A	33	
		Polymeric/paper (3 core)	35 - 150	35 - 120	72	
	M85	Polymeric/paper (1 core)	800 - 1.000	N/A	82	
		Polymeric/paper (3 x 1 core)	95 - 240	N/A	38	
		Kunststof/papier (3 core)	95 - 240	95 - 185	82	
	M105	Polymeric/paper (1 core)	800 - 1.000	N/A	105	
		Polymeric/paper (3 x 1 core)	95 - 400	N/A	48	
		Polymeric/paper (3 core)	95 - 400	300	105	
	MK125	Polymeric/paper (3 x 1 core)	95 - 800	N/A	58	
		Kunststof/papier (3 core)	95 - 500	N/A	120	
	24 kV	M75	Polymeric/paper (1 core)	95 - 240	N/A	72
		M85	Polymeric/paper (1 core)	300 - 630	N/A	82
			Polymeric/paper (3 x 1 core)	95 - 150	N/A	38
			Polymeric/paper (3 core)	95 - 150	95 - 150	82
		M105	Polymeric/paper (1 core)	800 - 1.000	N/A	105
Polymeric/paper (3 x 1 core)			95 - 400	N/A.	48	
Polymeric/papier (3 core)			95 - 400	240	105	
MK125		Polymeric/paper (3 x 1 core)	95 - 800	N/A	58	
		Polymeric/paper (3 core)	95 - 500	N/A	120	
36 kV		M85	Polymeric/paper (1 core)	70 - 500	N/A	82
		M105	Polymeric/paper (1 core)	630 - 1.000	N/A	105
		MK125	Polymeric/paper (3 x 1 core)	70 - 500	N/A	58
Polymeric/paper (3 core)	70 - 500		N/A	120		



\* Attention: Dependent on the outer sheath diameter and selected cable module. The above sizes concern cables that fit into the joint. Different cables on request.

## Build up LoviSil® Transition and straight through joints

### LoviSil® M75-M105 (12-24 kV)

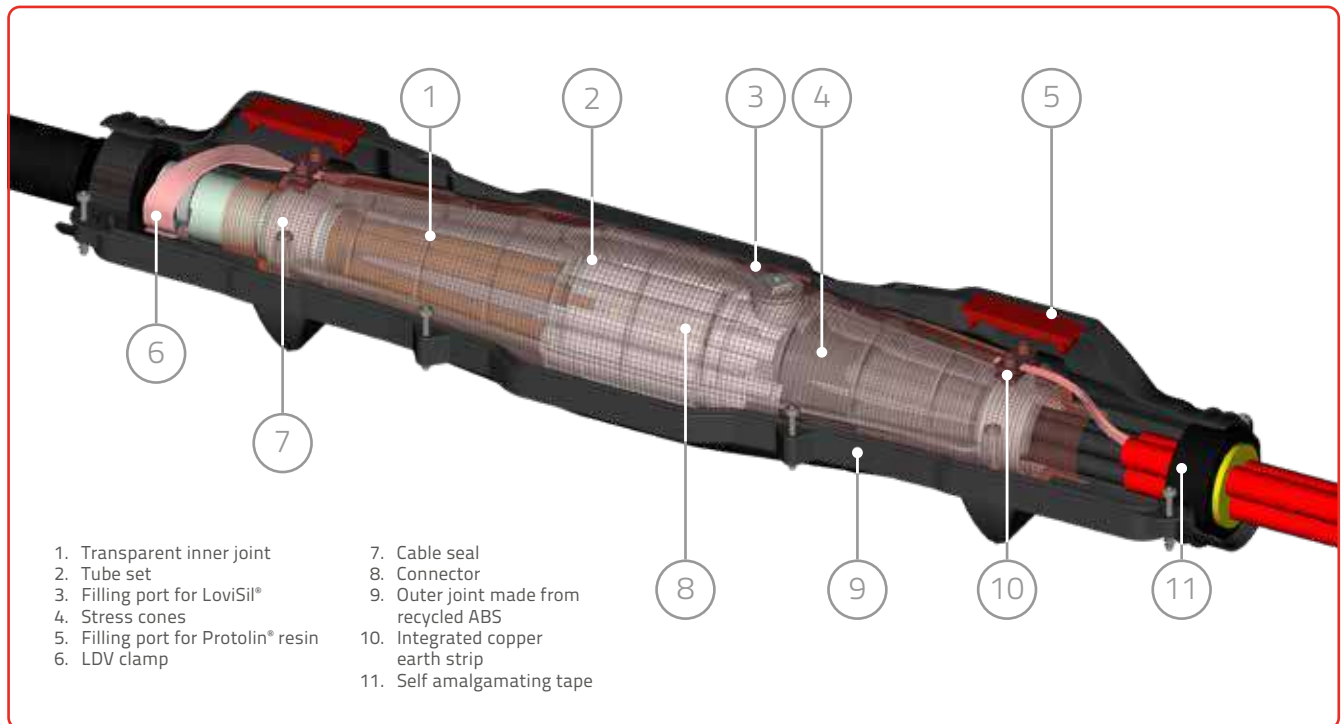

### LoviSil® M85-M105 (36 kV)

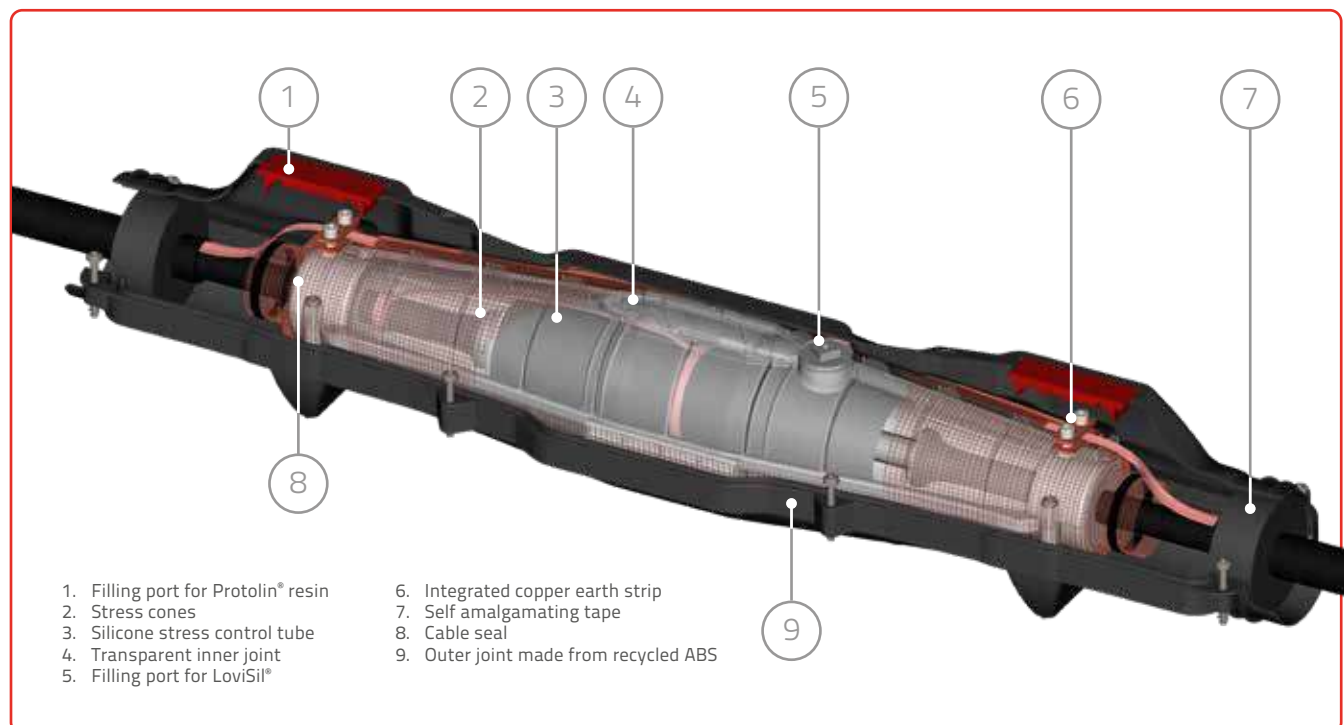

# LoviSil® MK125 (36 kV)

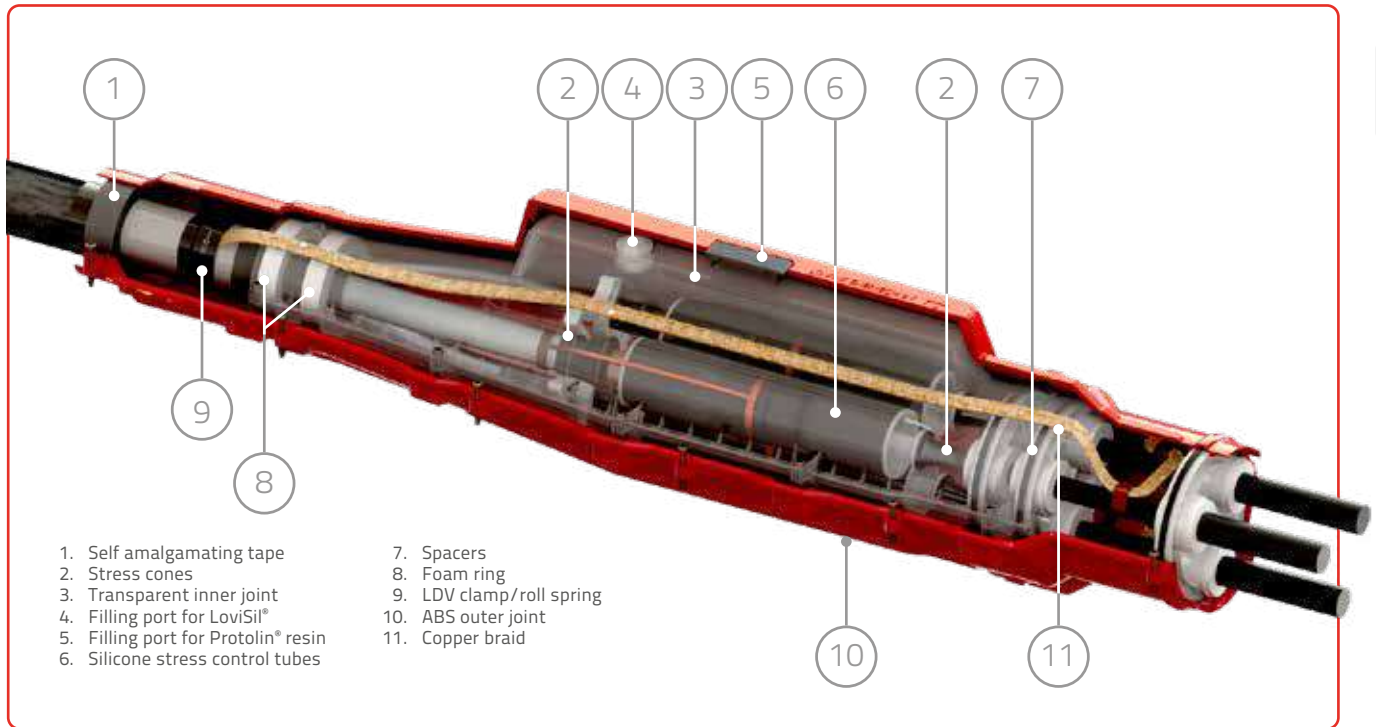

The MK125 is also available with an extension module for 3 core to 3 core cable applications.

Dimensions	Type	A (mm)	B (mm)
<p>M</p>	M75	1.048	218
	M85	1.128	237
	M105	1.386	289
<p>MK</p>	MK125	1.600	310
<p>MK with extension module</p>	MK125 Extended	1.870	310

## Optional versions

**Stop-End joint** > With the stop end module, a standard joint becomes a pot-end for cables that will be energized



### Application

An end joint can be applied at the end of a cable trace or when a cable trace is (partly) put out of operation.

### Benefits

- Easy to accomplish.
- A stop-end module converts a standard joint.

**Extended joint** > With an extension shell, the cable entry and connection space for the earth bond is extended



### Application

An extended shell offers greater space to bond additional components such as lead sheaths on polymeric cables or DWA.

### Benefits

- More bonding length and better water sealing
- Available on single or both ends
- Well suited to the petrochemical industry.

**Cross-bonding joint** > Used where cross-bonding is required to reduce losses



### Application

Underground solution to prevent compensating currents.

### Benefits

- Reduce cable losses
- Cost savings due to less cable losses

Voltage	Type	Cable	Conductor size (mm <sup>2</sup> )*	Diameter conductor crossed conductors (mm <sup>2</sup> )	Max. cross section for crossed cores (mm)
12 kV	M75	Polymeric (1 core)	95 - 630	N/A	72
	M85	Polymeric (1 core)	800 - 1.000	N/A	82
24 kV	M75	Polymeric/paper (1 core)	95 - 240	N/A	72
	M85	Polymeric (1 core)	300 - 630	N/A	82
	M105	Polymeric (1 core)	800 - 1.000	N/A	105
36 kV	M85	Polymeric (1 core)	70 - 500	N/A	82
	M105	Polymeric (1 core)	630 - 1.000	N/A	105

\* Attention: Dependent on the outer sheath diameter and selected cable module.  
The above sizes concern cables that fit into the joint. Different cables on request.

# Repair solutions

In case of limited cable damage, it is not always necessary to replace a large piece of cable and to install additional cable joints. A much faster and more sustainable solution is to use a LoviSil® repair joint.

After removing the damaged part of the cable, it can be replaced with a loose core that is secured on both sides or extended connectors are used. The connection is then

provided with an extended tube set and the other parts of the LoviSil® joint.

The insulation with liquid silicone and the strong housing with Protolin® resin make the connection very solid. With this solution, the quality and protection of the cable is guaranteed in the long term.

**Repair joint** > By means of an extended tube set it is possible to reconnect the cable after repair with the LoviSil® technology



### Application

A repair joint offers a simple solution to cable damage.

### Benefits

- Fast and sustainable solution
- Cost and work savings

Voltage	Type	Cable	Conductor size (mm <sup>2</sup> )*	Diameter conductor crossed conductors (mm <sup>2</sup> )	Max. cross section for crossed cores (mm)
12 kV	M105	Polymeric/paper (3x1 core)	35 - 400	N/A	48
		Polymeric/paper (3 core)	35 - 400	35 - 300	105
24 kV	M105	Polymeric/paper (3x1 core)	95 - 400	N/A	48
		Polymeric/paper (3 core)	95 - 400	95 - 150	105

1-core repair joints on request.

### Repair length

Conductor size (mm <sup>2</sup> )	Max. repair length (mm)
16-95	330
50-150	300
95-240	270
185-400	225

# Sustainable solutions

An important objective in the electricity sector is to utilize the cable network in a sustainable manner. This can be achieved by extending the life of aging paper cables where possible. The oil refill joint offers a perfect solution.

## Extending cable network life span

New network sub stations are designed around switchgear for connection to polymeric cables. This requires the installation of transition joints to allow connection to existing PILC networks. In turn, this often results in disconnection from oil supplies essential to existing paper-insulated cables, thus making them susceptible to drying out and inevitable failure. Lovink Enertech has devised a special transition joint that continuously supplies oil to these cables thus preventing them from drying out.

## Effective solution

A simple technique has been devised to remove a section of lead sheath without compromising the cores beneath.

A special manifold, which includes a non-return valve, is then positioned over the opening and secured in place. This enables connection to an oil supply suitable for the cable concerned. Utilizing a tube along with traditional couplers and pipe-work, oil can be supplied from a conveniently located reservoir allowing easy maintenance.

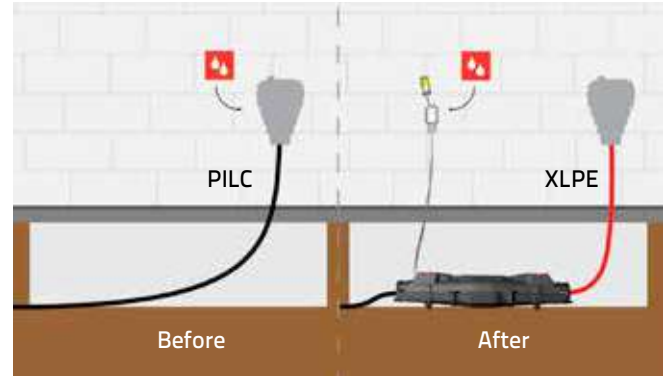

LoviSil® oil refill joint

**Oil refill joint** > By means of a special manifold, a connection is made between the metallic sheath and an oil reservoir

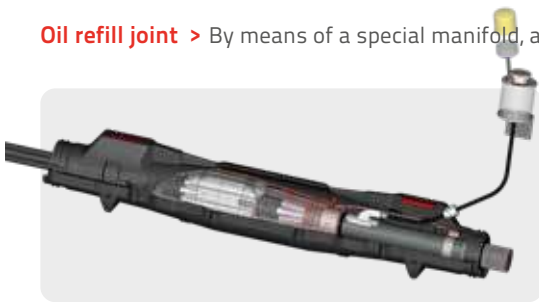

### Application

Where transitions from paper to polymeric cables are required on new construction, oil refill joints feed the paper cable to extend their life.

### Benefits

- Continuous supply of oil
- Prevents drying out
- Extending cable network life

Voltage	Type	Cable (mm <sup>2</sup> *)	Conductor size (mm <sup>2</sup> )*	Type	Construction
12 kV	M75	Paper (3 core)	35 -300	1 x lead	Without inner joint
	M85	Paper (3 core)	300 -400	1 x lead	Without inner joint
	M105	Paper (3 core)	95 - 400	3 x lead	Without inner joint
		Paper on polymer (3 core)	25 -150	Connection 1 x lead	M75 inner joint
		Paper on polymer (3 core)	50 - 240	Connection 1 x lead	M85 inner joint
24 kV	M75	Paper (3 core)	35 -185	1 x lead	Without inner joint
	M85	Paper (3 core)	240 -400	1 x lead	Without inner joint
	M105	Paper (3 core)	70 - 400	3 x lead	Without inner joint
		Paper (3 core)	35 -150	Connection 1 x lead	M85 inner joint
		M75	Paper (3 core)	35-70	1 x lead
36 kV	M85	Paper (3 core)	95-120	1 x lead	Without inner joint
	M105	Paper (3 core)	150 - 400	1 x lead	Without inner joint
		Paper (3 core)	70 - 300	3 x lead	Without inner joint
		Paper (3 core)			

\* Attention: Dependent on the outer sheath diameter and selected cable module. The above sizes concern cables that fit into the joint. Different cables on request.

# Product overview LoviSil® KB Branch joints

LoviSil® KB Branch joints are suitable for making connections in medium voltage networks. The branch joint can be applied regardless of the main cable type. With LoviSil® joints, polymeric cables can be directly connected to paper or polymeric cables. No external transition joints are needed, resulting in reduced material, excavation and reinstatement costs.

Voltage	Type	Cable	Conductor size** (mm²)*	Diameter conductor crossed conductors** (mm²)	Max. cross section for crossed cores (mm)	
12 kV	KB85	Polymeric/paper (1 core)	95 - 1.000	N/A.	82	
		Polymeric/paper (3 x 1 core)	70 - 240	N/A.	38	
		Polymeric/paper (3 core)	70 - 240	95 - 185	82	
	KB95	Polymeric/paper (1 core)	95 - 1.000	N/A.	87	
		Polymeric/paper (3 x 1 core)	120 - 300	N/A.	40	
		Polymeric/paper (3 core)	120 - 300	150-240	87	
24 kV	KB85	Polymeric/paper (1 core)	70 - 240	N/A.	82	
		KB95	Polymeric/paper (1 core)	95 - 1.000	N/A.	87
			Polymeric/paper (3 x 1 core)	120 - 300	N/A.	40
	Polymeric/paper (3 core)		120 - 300	240	87	
	36 kV	KB95	Polymeric/paper (1 core)	95 - 1.000	n.v.t.	87

\* Attention: Dependent on the outer sheath diameter and selected cable module.

The above sizes concern cables that fit into the joint. Different cables on request.

\*\* Sector shaped conductors 240 mm² (KB85) and 300 mm² (KB95) needs to be pressed circular.

## Build up LoviSil® KB Branch joints

### LoviSil® KB85-KB95

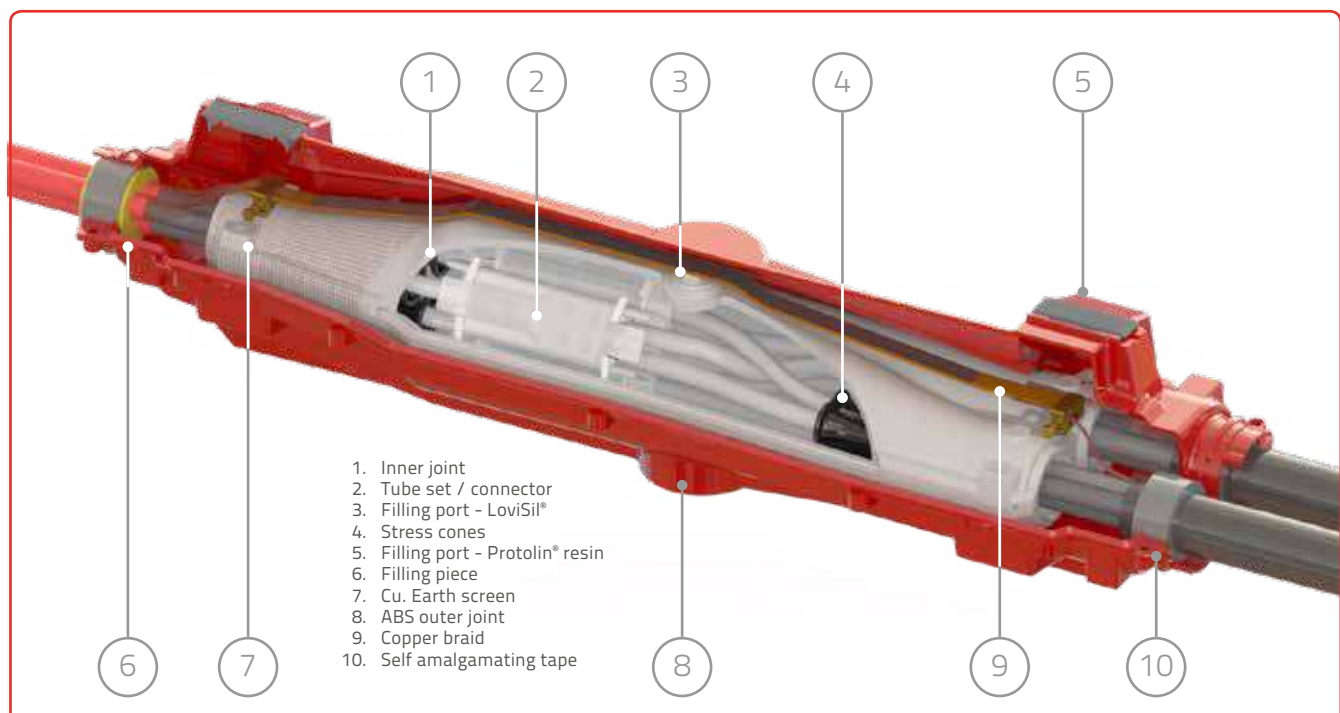

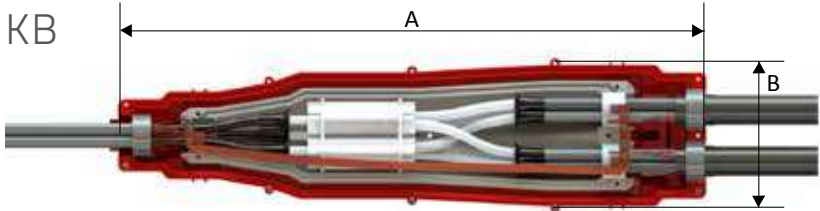
Dimensions		A (mm)	B (mm)	
KB		KB85	1.280	305
		KB95	1.500	320

### Optional versions

**Loop joint** > With a stop-end module, a standard branch joint becomes a loop joint



#### Application

Where a substation or switchgear is to be abandoned, the ring feeder cables laid parallel in the ground can be connected without excavation to accommodate a large loop and two straight joints. Both cables are installed on the branch side.

#### Benefits

- Less excavation work
- Less cable needed
- Shorter assembly time

**Feed-in joint** > With a special connector a standard branch joint becomes a feed-in joint



#### Application

A feed-in joint can be used to connect power from new sustainable sources to existing cable runs or new radial circuits.

#### Benefits

- Less excavation work
- Less cable needed
- Sub station redundant
- Shorter assembly time

## Sustainable applications

Application of the LoviSil® branch joints often lead to substantial cost savings, less cable and fewer cable joints are needed. When a substation is decommissioned and cables must stay in operation, the LoviSil® loop joint offers a practical solution. The normal approach for this procedure is to join the cables together by installing two cable joints plus a loop of new cable. However the LoviSil® loop joint allows the two cables to be mounted directly without an extra cable. Branch joints can accommodate a wide range of cable types, including small single core polymeric cables from wind turbines.

**LoviSil® Feed- in joints** are fitted with a specially developed connector which enables jointing of small cross section source cables to large cross section radial or ring cables.

This application reduces the need for additional switchgear and sub stations. Together with saving extra cable length and extra excavation work makes the **LoviSil® branch joint** an economic investment.

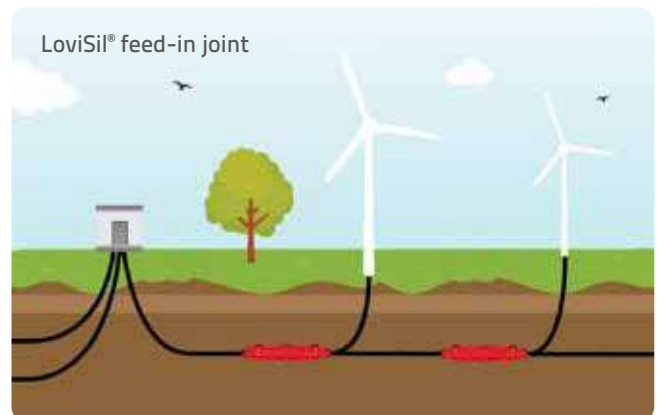



# LoviFlex<sup>®</sup> GSE Terminations



# LoviFlex®

## GSE Terminations



The LoviFlex® termination is made of a strong housing made of ABS and silicone rubber. The termination is filled with LoviSil® that guarantees perfect electrical insulation. Due to the use of LoviSil® liquid silicone technology, the termination is maintenance-free and can be installed safely without oil.

### Application

LoviFlex® GSE terminations are suitable for installation with paper insulated cables in switch gear stations. LoviSil® liquid keeps the cables in optimal condition to last for years to come.

### Reliable and installer-friendly

The connection and housing are realized in just a few steps. The termination can be filled with fluid silicone immediately, without heating oil. LoviSil® migrates with the cable grease and thus prevents the paper cable from drying out. In addition, the LoviSil® in the termination is hardened after 2-3 weeks, making it unnecessary to refill afterwards. The two-part construction ensures that the LoviFlex® termination can also be mounted in tight spaces with ease.

### Tests

The LoviFlex® GSE termination has been successfully tested according to HD 629 / EN 61442.



### Supply

All parts are delivered in a handy box including a clear manual. The termination is supplied as a set for 3 phases.

Lifespan extension of existing assets

Maintenance-free: no refilling necessary

Safe for the installer: no oil-heating

# Program LoviFlex® GSE Terminations

LoviFlex® GSE terminations are developed for paper insulated cables and are suitable for a.o. Magnefix switch gear stations. The two-part construction enables a broad application even in tight spaces.

Voltage	Type	Nom. Cross Section mm <sup>2</sup>	Diameter mm max. on cable
12 kV	GSE	Al/Cu 16 - 95	85
		Al/Cu 95 - 240	85

## Dimensions



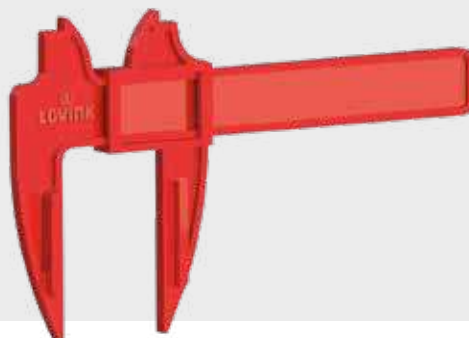



# Accessories



# Protolin® Polyurethane resin

**Protolin® 4000** > Cast resin which can be used as a mechanical insulation in medium voltage accessories



## Product information

- Two-part resin based on polyurethane.
- For applications with polymeric and paper-insulated cables.
- Supplied in a foil pouch, the twin compartment sachet allows easy mixing and pouring.
- The fully mixed resin flows easily, searching out the smallest spaces. Whilst curing, the resin is unaffected by water or moisture in the cable.
- Available in 1700, 2550 and 3150 cc.

## Tools

**Slide caliper** > Installation tool to establish the correct diameters when applying build-up tapes



## Product information

- Slide mechanism, single-handed operation.
- Universally applicable, diameter from 40 to 155 mm.

**Push on applicators** > Installation tool to position the stress cone on the cable



## Product information

- Available for 35 and 49 mm.

**Divisible push on applicators** > Installation tool to position the stress cone on the cable

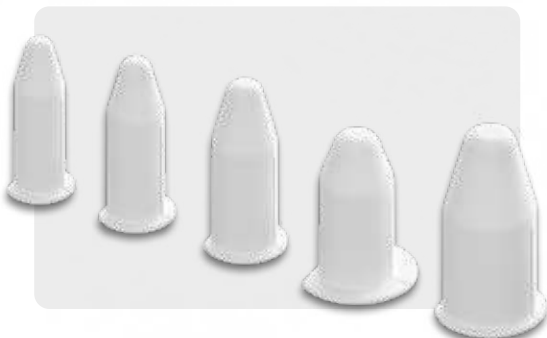

## Product information

- Available as a set with 3 x applicators 30, 37, 42, 49 mm and 2 x applicator 60 mm.

# Clamps and roll springs

**LDV clamp** > Solderless earth connection clamp for making an electrical connection of the lead sheath with the copper earth braid

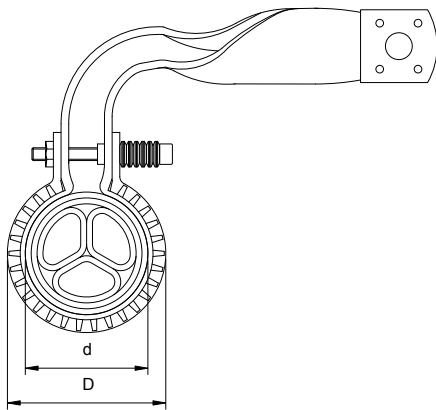

## Product information

- Suitable for use in cable joints and terminations on paper insulated cables up to 36 kV.
- Can be applied in open air, cast resin or bitumen.
- Successfully tested on PILC cable at 14.6 kA/1sec, (250 MVA).

Description	Diameter over lead sheath (mm)		Clamp diameter (mm)
	d <sub>min</sub>	d <sub>max</sub>	D
LDV 35	26	33	45
LDV 50-70	33	39	51
LDV 95	39	45	57
LDV 150	45	51	63
LDV 240	51	59	70
LDV 300	59	65	77

\* The above sizes concern cables that fit into the joint. Different cables on request.

# Roll springs

**Roll spring** > For making an electrical connection to lead sheath or Cu tape screen with the copper earth braid

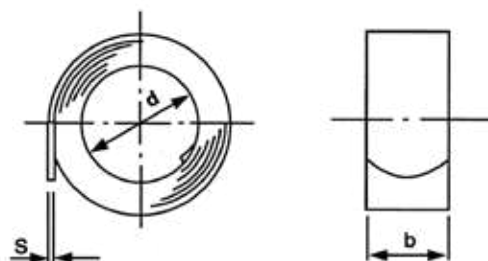

## Product information

- Made of non-corroding special steel.

Description	Application range (mm)		Dimensions (mm)			Coils
	Min.	Max.	d	b	s	n
RF 1	13	22	11,5	16,0	0,10	6
RF 2	17	29	13,5	16,0	0,15	6
RF 3	22	37	17,0	16,0	0,20	6
RF 4/5	30	70	24,0	19,0	0,30	6
RF 6	56	94	42,5	20,0	0,50	6

\* The above sizes concern cables that fit into the joint. Different cables on request.

## Cleaning materials

**Dispenser with cable cleaning cloths** > Saturated cleaning cloths in plastic container



### Product information

- Mixture of solvents, consisting of iso-paraffin hydrocarbons.
- It does not contain benzene, hexane and chlorinated hydrocarbons.
- The aromatic content is very low, maximum 0.05 (volume)percent.
- Dry cloths also available.

**Cable cleaning cloths** > Saturated cleaning cloths single packed



### Product information

- Mixture of solvents, consisting of iso-paraffin hydrocarbons.
- It does not contain benzene, hexane and chlorinated hydrocarbons.
- The aromatic content is very low, maximum 0.05 (volume)percent.
- Also available as set: 4 saturated and 2 dry cleaning cloths.

## Wrapping tapes

**Self-amalgamating build-up tape** > To enlarge cable diameters to meet the size of cable joints



### Product information

- Cold application.
- Complete seal, even on the overlap.
- Long aging.
- Good electrical resistance.
- Resistant to acids, alkalis, salt solutions and all corrosive substances in the ground.
- Dimensions: 4 m x 40 mm x 1 mm.

**Self-amalgamating insulation tape 128** > Provide protection against accidental contact with uninsulated parts



### Product information

- Resistivity: 1015  $\Omega$  cm.
- Dielectric constant: 2.3.
- DIN 53 482 and DIN 53 483.
- Dimensions: 5 m x 20 mm x 1 mm.

**Self-amalgamating conductive tape K** > To provide stress control and shielding in joints and terminations



#### Product information

- Resistivity 103  $\Omega$  cm.
- Tear strength: 3 N/mm<sup>2</sup>.
- Ultimate elongation: 200%.
- DIN 53 482 and DIN 53 455.
- Dimensions: 2.3 m x 19 mm x 0.75 mm / 4.6 m x 19 mm x 0.75 mm.

**Self-amalgamating insulation tape SVIM** > To provide insulation in cable terminations and straight joints



#### Product information

- Resistivity 1015  $\Omega$  cm.
- Tear strength: 3 N/mm<sup>2</sup>.
- Ultimate elongation: 800%.
- Dielectric constant: 2.8.
- Service temperature: -40 °C to 100 °C.
- DIN 53 482, DIN 53 455, DIN 53 481 and DIN 53 483.
- Dimensions: 4.5 m x 19 mm x 0.75 mm / 10.0 m x 19 mm x 0.75 mm.

**Foam tape** > To adjust the cable diameter for the use of foam rings in cable joints



#### Product information

- Single sided sticking tape
- Dimensions: 4 m x 25 mm x 2 mm
- Dimensions : 4 m x 50 mm x 2 mm

Lovink Enertech has made every effort to ensure the reliability and accuracy of the information contained in this catalogue at the time of going to press. The company shall not be held liable for the accuracy and completeness of this document. Lovink Enertech B.V. reserves the right to make changes in product and documentation specifications at any time and without notice. The reference lifespan stated in this catalog corresponds to average data used for impact calculation, taking into account the average time a cable accessory is installed in a system before it is removed. It CANNOT be considered an equivalent of the guaranteed technical lifespan of the product.

